

**WM-3007-T**  
**HD LCD WAVEFORM MONITOR**

**Instruction Manual**

September 29, 2004

2nd Edition

Software Version 1.00

**ASTRODESIGN, Inc.**

# CONTENTS

<b>SAFETY PRECAUTIONS</b> .....	<b>5</b>
<b>CHAPTER 1 CONCERNING THE WM-3007-T</b> .....	<b>8</b>
1.1 Outline of WM-3007-T.....	8
<b>CHAPTER 2 PARTS AND THEIR FUNCTIONS</b> .....	<b>9</b>
2.1 WM-3007-T front panel view, and parts and their functions.....	9
2.2 WM-3007-T rear panel view and parts.....	11
<b>CHAPTER 3 OPERATION</b> .....	<b>13</b>
3.1 Connections.....	13
3.2 Usage.....	14
3.3 Concerning the screens.....	14
3.3.1 PICTURE1 mode.....	15
3.3.2 PICTURE2 mode.....	19
3.3.3 WAVEFORM mode.....	20
3.3.4 VECTOR mode.....	23
3.3.5 STATUS mode.....	25
3.3.6 AUDIO mode.....	27
3.4 Operation.....	30
3.4.1 PICTURE1 mode.....	31
3.4.1.1 Function screen.....	32
3.4.1.2 Brightness setting screen.....	33
3.4.1.3 Contrast setting screen.....	35
3.4.1.4 Chroma setting screen.....	37
3.4.1.5 Gamma setting screen.....	39
3.4.1.6 Other video setting screen.....	41
3.4.1.7 Color setting screen.....	43
3.4.2 PICTURE2 mode.....	44
3.4.2.1 Regular screen.....	45
3.4.2.2 User marker setting screen.....	47
3.4.2.3 Color setting screen.....	48
3.4.3 PICTURE3 mode.....	49
3.4.3.1 Regular screen.....	50
3.4.3.2 Color setting screen.....	52
3.4.4 WAVEFORM mode.....	53
3.4.4.1 Function screen.....	54
3.4.4.2 DISPLAY setting screen.....	55
3.4.4.3 SWEEP setting screen.....	57
3.4.4.4 GAIN/MAG setting screen.....	59
3.4.4.5 CURSOR setting screen.....	61
3.4.4.6 WAVEFORM mode setting screen.....	63
3.4.4.7 Color setting screen.....	65
3.4.5 VECTOR mode.....	67
3.4.5.1 Regular screen.....	68
3.4.5.2 VECTOR mode setting screen.....	70
3.4.5.3 Color setting screen.....	72

3.4.6	STATUS mode .....	73
3.4.6.1	Regular screen .....	74
3.4.6.2	Color setting screen .....	76
3.4.7	AUDIO mode .....	77
3.4.7.1	Audio level meter screen .....	78
3.4.7.2	Audio vector screen .....	79
3.4.7.2	Color setting screen .....	81
3.4.8	Multi mode .....	82
3.4.8.1	Multi mode 1 screen .....	83
3.4.8.2	Multi mode 2 screen .....	85
3.4.9	Option mode .....	86
3.4.10	MENU mode .....	88
3.4.10.1	Regular screen .....	88
3.4.10.2	Color setting screen .....	90
<b>CHAPTER 4 MAIN SPECIFICATIONS</b>		
4.1	Input formats .....	91
4.2	Input formats .....	92
4.3	Display system .....	92
4.4	Headphones output .....	93
4.5	Concerning the adjustment values .....	93
4.6	Concerning the picture magnification display function .....	95
4.7	Reference correspondence table .....	97
4.8	Settings at initialization .....	98
4.9	General specifications .....	102
4.10	Outline drawings .....	103
<b>CHAPTER 5 STANDARD AND OPTIONAL ACCESSORIES ..... 104</b>		
5.1	Standard accessories .....	104
<b>CHAPTER 6 MAINTENANCE AND RELATED ASPECTS ..... 105</b>		
■	When the monitor does not function properly .....	105
■	The following situations are not indicative of trouble or malfunctioning. ....	105
■	When trouble or malfunctioning occurs .....	106
■	Concerning this manual .....	106
■	In using the WM-3007-T .....	106

## INTRODUCTION

Thank you very much for purchasing this model WM-3007-T HD LCD waveform monitor. This manual contains details on the operation procedures to be followed when the WM-3007-T is used, the checkpoints and precautions to be observed, and other useful information.

Improper handling may result in malfunctioning. Before using the WM-3007-T, please read through these instructions to ensure that you will operate the monitor correctly.

After reading through the manual, keep it in a safe place for future reference.

## SAFETY PRECAUTIONS

### WARNING

#### Concerning the monitor

- Do not subject the monitor to strong shocks or throw it around. Doing so may cause the liquid crystal to leak and/or the monitor to malfunction, rupture, generate heat and cause a fire.
- Do not use the monitor wherever there is a risk of ignition or explosions.
- Do not place the monitor inside a microwave oven or other heating or cooking appliance or pressure vessel. Doing so may cause heat or smoke to be generated in the monitor, combustion and/or damage to the circuit components.
- Inside the monitor are some high-voltage parts: since exposure to these parts may result in electric shocks or burns, refrain from disassembling, repairing or remodeling the monitor.
- If a thunderstorm should occur while the monitor is being used outdoors, immediately turn off its power, disconnect the power cable and battery from the main unit, and move the monitor to a safe place.

#### Concerning the power cord

- Always take hold of the molded part of the plug when disconnecting the power cord.
- Do not apply force to bend the power cord or bunch it up for use. This may cause a fire.
- Do not place heavy objects on top of the power cord. This may damage the cord, causing a fire or electrical shock.

#### Concerning foreign matter

- Do not spill liquids inside the monitor or drop inflammable objects or metal parts into it. Operating the monitor under these conditions may cause a fire, electric shocks and/or malfunctioning.

## CAUTION

### Concerning the power supply

- Use a supply voltage within the range of 10V-18V DC for the monitor.
- Do not turn the power back on immediately after having turned it off. Doing so can cause malfunctioning.
- Bear in mind that using the same DC power supply as for a microphone, amplifier, speakers or other audio products may adversely affect the sound.

### Concerning the liquid crystal

- Due to the nature of liquid crystal, some picture elements may be missing (bright spots, dark spots, etc.) at times.
- Do not touch any liquid crystal which has leaked from the liquid crystal panel.  
If the liquid crystal panel has been damaged by mistake and the liquid (liquid crystal) inside has leaked out, keep the liquid away from your mouth and skin and do not inhale its odors.  
In the event that liquid crystal has made contact with your eyes or mouth, use water to rinse it off immediately.  
If it has come into contact with your skin or clothing, wipe it off immediately with alcohol, and then rinse it off with soap. Leaving it in place may damage your skin or clothing.
- Exercise care with the glass of a broken liquid crystal panel. If the panel has broken, be careful not to cut your hands on the glass shards. If you should touch an area where the glass has broken off, you may injure yourself.
- The LCD panel is a high-precision component and, as such, the following care must be taken in its handling.
  - 1) Wiping the panel's surface with benzine, paint thinners, etc. will cause a deterioration in its quality.
  - 2) If water (salty water) is left on the display surface, discoloration and staining will result.
  - 3) Exposing the panel directly to ultraviolet rays for an extended period causes the deflection panel to turn brown, in turn causing the contrast to drop and other forms of deterioration to develop in the display quality.
  - 4) Moisture inside the monitor due to condensation, etc. may cause unevenness in the colors.
  - 5) Directly tapping the surface or bumping it into objects may crack the panel, etc.
  - 6) Do not attempt to disassemble the panel since leaking liquid crystal may make contact with your skin, which is hazardous.
- Handle the liquid crystal protective panel carefully.  
Gently wipe off any fingerprints or dirt on the liquid crystal protective panel with a cleaning agent used to clean office automation equipment. Rubbing the panel with too much force may mark or damage the panel.

### Concerning impact

- This is a precision instrument and, as such, subjecting it to impact may cause malfunctioning. Take special care when moving the monitor.
- Do not drop the monitor.

## Concerning installation and operation locations

- Installing the monitor in the following kinds of locations may cause malfunctioning and/or accidents.
  - 1) Locations with an ambient temperature outside the range of 0 -40 degrees Celsius (see Note 1)
  - 2) Locations with an ambient humidity outside the range of 30-80% RH
  - 3) Locations in the vicinity of an air conditioner or subject to rapid temperature changes or the formation of condensation
  - 4) Locations exposed to direct sunlight (see Note 2)
  - 5) Locations exposed to corrosive gases or high concentrations of dust
  - 6) Locations where strong magnetic fields are generated
  - 7) Locations where the monitor may be splashed with water, oil, chemicals, etc.
  - 8) Locations to which vibrations are transmitted from the floor
  - 9) Unstable locations

Note 1: When the surface temperature of the LCD panel exceeds 60 degrees Celsius, the panel's backlight and other parts may be damaged.

Note 2: Exposing the panel directly to ultraviolet rays for an extended period causes the deflection panel to turn brown, in turn causing the contrast to drop and other forms of deterioration to develop in the display quality.

- Take care to avoid the following actions in order to ensure that the monitor will be used properly.
  - 1) Do not place heavy objects such as another monitor directly on top of the monitor.
  - 2) Avoid placing any objects around the monitor.
  - 3) Avoid using the monitor while it is placed on top of another device.

## CHAPTER 1 CONCERNING THE WM-3007-T

The WM-3007-T is a compact, lightweight and portable LCD waveform monitor which comes in handy for monitoring the pictures being shot during live broadcasts, on location or in studios, etc.

A full range of functions is provided including functions for adjusting the brightness, contrast and chroma level as well as functions for displaying markers.

Input signals in a total of 23 HDTV and two SDTV video formats are supported.

### 1.1 Outline of WM-3004

- 8.4-inch a-Si TFT LCD panel featured
- Input of HD-SDI, SD-SDI, YPbPr HD analog and GBR HD analog signals supported (\*)  
(HD analog signals: Y or G-on-sync)
- 25 different video formats supported  
Standards for HD-SDI: SMPTE 292M, BTA-S004B standards complied with (1.485 Gbps SDI input)  
Standards for SD-SDI: SMPTE 259M standard complied with (270 Mbps SDI input)  
Standards for analog input and supported formats: SMPTE 274M, SMPTE 296M, BTA-S001B standards complied with
- SDI IN (x2), SDI MONITOR OUT, HD analog input (ANALOG Y/G, ANALOG Pb/B, ANALOG Pr/R) and REF IN connectors provided
- Brightness, contrast, chroma, filter, monochrome and Y gamma adjustment functions
- Marker display functions (FRAME, CENTER, USER, 95%, 93%, 88%, 80%, 4:3, 13:9, 14:9, 2.35:1, 1.85:1, 1.66:1)
- Single-action operation of input channels, partial display/non-display of information, picture overlay and freeze/update selection using the switches on the front panel
- Lighting of red, green LEDs at top of screen by contact supply-type tally inputs
- Automatic searching of input signals possible
- Automatic 1/1.000 and 1/1.001 frame rate searching and input signal detection functions
- 6500K/9300K color temperature selection enabled (subtle hue and gray scale adjustments also possible)
- CRC error detection function (during HD-SDI input) for input channels
- Time code (VITC) display (during HD-SDI input)
- Functions for locking the panel switches and storing the setting values
- Saving of data as user data and loading of user data enabled
- Function for reducing power consumption to a low level by turning off the LCD backlight
- Light weight and compact size
- DC supply power input (10 to 18V)

(\*) Simplified display for the GBR HD analog signals

## CHAPTER 2 PARTS AND THEIR FUNCTIONS

### 2.1 WM-3007-T front panel view, and parts and their functions

WM-3007-T front panel view

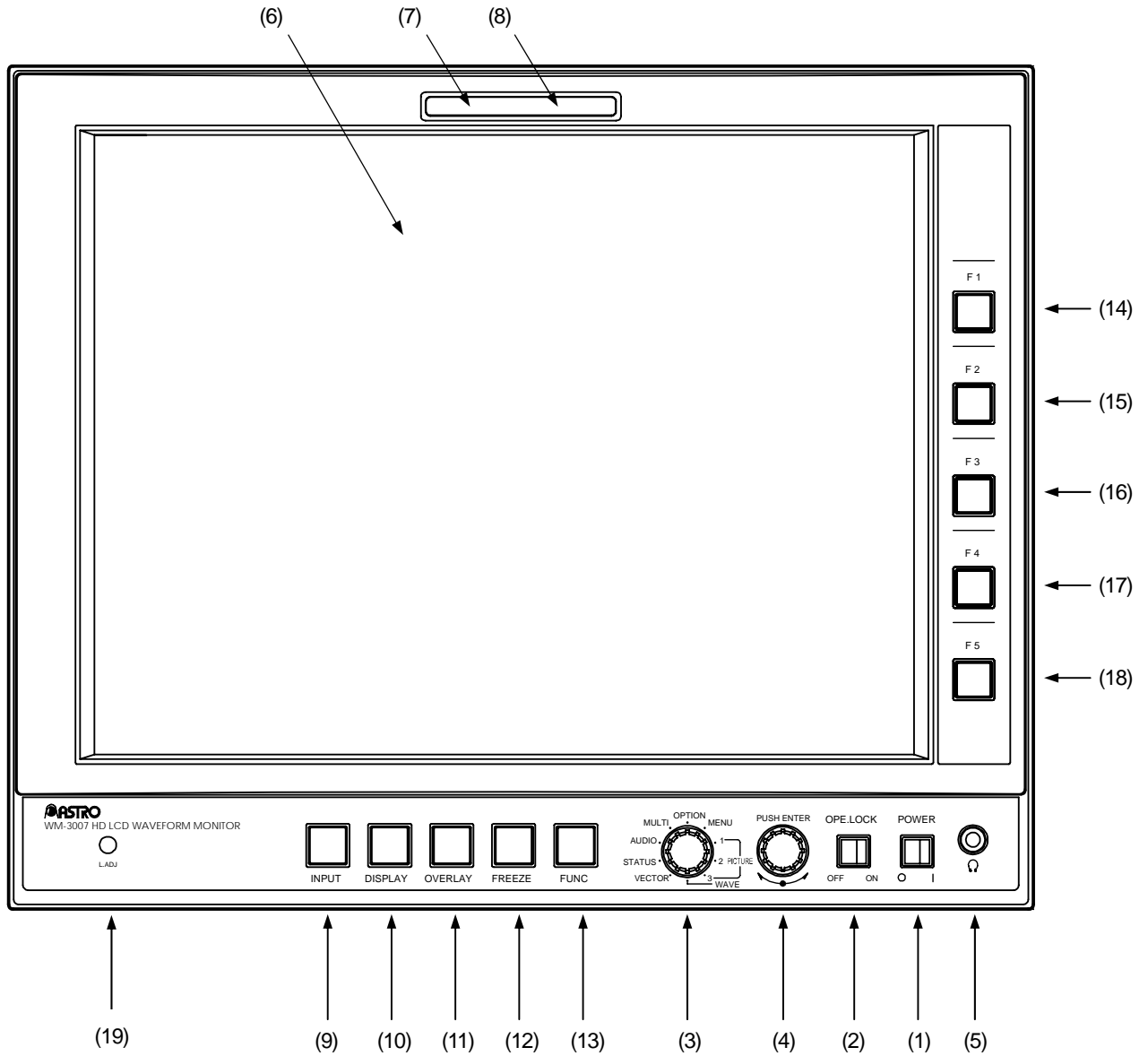

## Front panel parts

Number	Part	Description of function
(1)	POWER SWITCH/LED	This switch is used to turn the power ON and OFF. (Its LED lights up green while the power is supplied.)
(2)	LOCK SWITCH/LED	This switch is used to lock the panel switches and save the setting values simultaneously.  Wait appears at the bottom right of the screen while the settings are being saved. The settings which have been saved are loaded when the power is turned on. Do not turn off the power while the setting saving process is in progress. If the LOCK switch is released or the power is turned off while settings are being saved, the initial value may be set instead of the settings to be saved. (The LED of this switch lights up yellow while the panel switches are locked.)
(3)	Mode switch	This switch is used to select the monitor's mode. The mode is selected in the following sequence: PICTURE1 → PICTURE2 → PICTURE3 → WAVEFORM → VECTOR → STATUS → AUDIO → MULTI → OPTION → MENU.
(4)	Adjustment dial	This dial is used to adjust and select the settings.
(5)	Headphone jack	The sound is output from this jack (diameter: 35 mm). (*1)
(6)	Liquid crystal display	The images appear on this display.
(7)	TALLY 1	Tally lamp (red): This is controlled by the rear panel tally connector (contact supply type).
(8)	TALLY 2	Tally lamp (green): This is controlled by the rear panel tally connector (contact supply type).
(9)	INPUT switch	This switch is used to select SDI A or SDI B for the input signals. When it is held down (for more than one second), analog signals are input. If the freeze function is activated at this time, it will be released.
(10)	DISPLAY switch	This switch is used to set whether the information is to be partially displayed on the screen or not displayed at all. When it is held down (for more than one second), the top and bottom of the screen are inverted.
(11)	OVERLAY switch	This switch is used to change the picture overlay settings. It has no effect in the PICTURE 1, 2 or 3 mode since the picture is displayed all the time in any of these modes. When it is held down (for more than 1 second), the color setting screen appears. (The items whose colors are to be set differ according to the mode selected.)
(12)	FREEZE switch	This switch is used to select freeze or update. If interlace applies for the format, the picture in the first field is displayed as the picture. Freeze is released by switching the input signals or format or by loading data in the option mode. Bear in mind that if the input signals are cut off in the freeze status or their format has been changed, the correct data will not be output. In the PICTURE3 mode, the freeze function does not work in the H Delay ON, V Delay ON or MAG (x2 or x4) status. In the AUDIO mode, the freeze function does not work while the audio vector screen is displayed. The CRC errors are counted even in the freeze status.
(13)	FUNC switch	This switch is used to select the function switches (switches F1 to F5).
(14)	F1 switch	The function of this switch is different depending on each menu which is selected.
(15)	F2 switch	The function of this switch is different depending on each menu which is selected.
(16)	F3 switch	The function of this switch is different depending on each menu which is selected.
(17)	F4 switch	The function of this switch is different depending on each menu which is selected.
(18)	F5 switch	The function of this switch is different depending on each menu which is selected.
(19)	Adjustment control	This control is used to adjust the LCD backlight. (*2)

Note 1: Audio signals are output when 48 kHz embedded sound has been multiplexed in the SDI signals.

Note 2: When the LCD backlight adjustment control is used to reduce the brightness, a ripple voltage of around 300 Hz may be generated in the DC power input.

## 2.2 WM-3007-T rear panel view and parts

WM-3007-T rear panel view

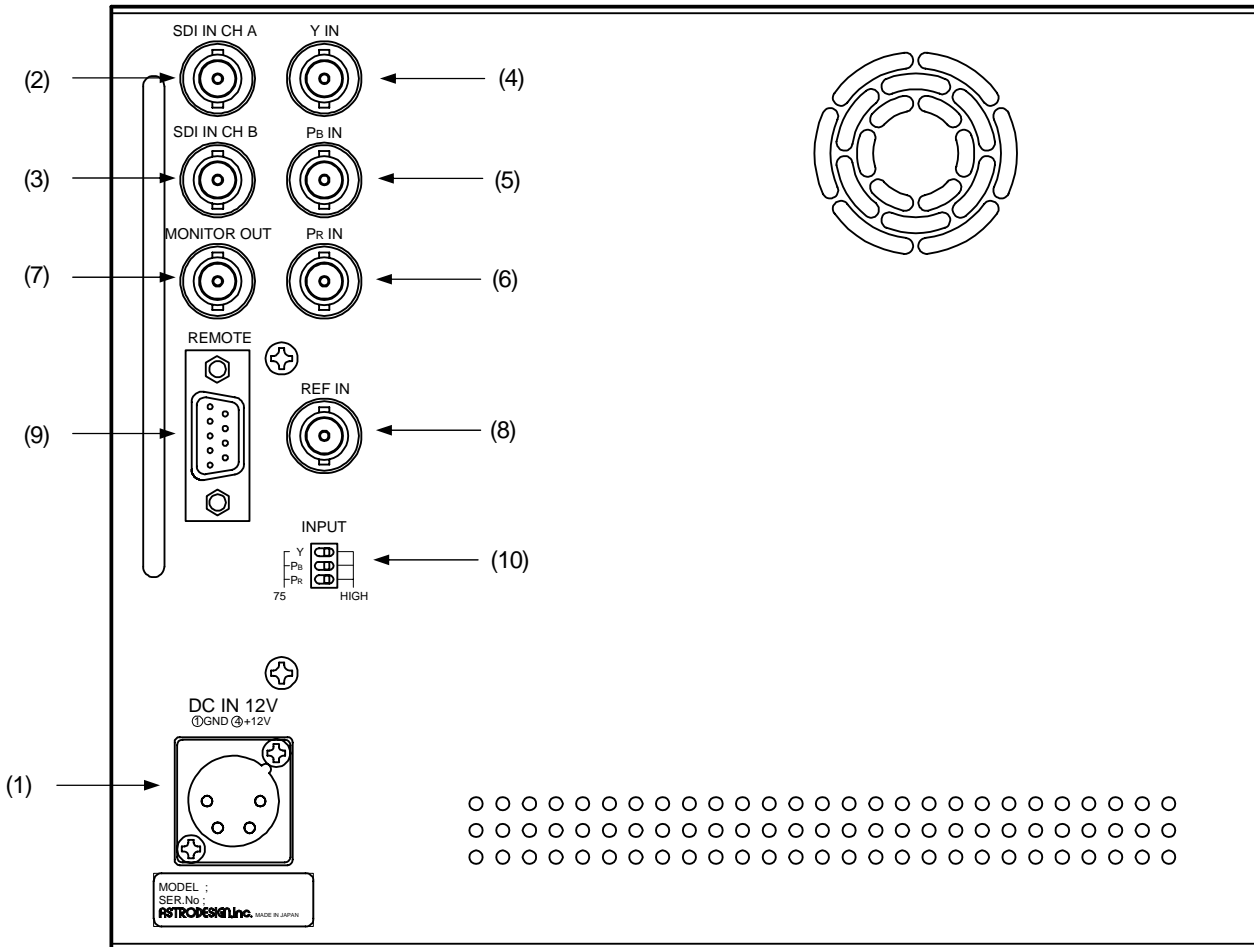

Rear panel parts

Number	Part	Description of function
(1)	Power socket (*1)	Cannon connector, DC power input socket (GND: pin 1; DC IN: pin 4).
(2)	SDI IN Ach	HD-SDI, SD-SDI signal input connector.
(3)	SDI IN Bch	HD-SDI, SD-SDI signal input connector.
(4)	Y IN	HD analog Y/G signal input connector Synchronization is provided by the Y/G signal in the case of analog inputs.
(5)	Pb IN	HD analog Pb/B signal input connector.
(6)	Pr IN	HD analog Pb/R signal input connector.
(7)	MONITOR OUT	Output connector for simplified monitoring of SDI input signals. SDI A images are output when the SDI A input is selected. SDI B images are output when the SDI B input is selected. SDI A images are output when the analog input is selected.
(8)	REF IN	Reference input signal connector. (HD tri-level sync signal and NTSC/PAL black burst signal)
(9)	TALLY connector (*2)	D-sub 9-pin (female) connector.
(10)	Termination selector switch (*3)	This is used to enable or disable the 75-ohm termination for the analog signals.

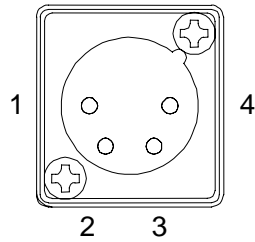
**\*1: Power socket (no. <1>)**

Pin No.	Description of function
1	GND
2	NC
3	NC
4	DC IN (10-18V)

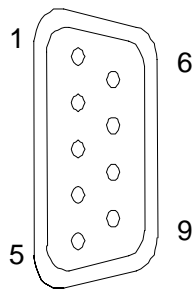
**\*2: TALLY connector (no. <9>)**

Pin No.	Description of function
1	GND
2	TALLY2 (green)
3	NC (Reserved) (Note)
4	NC (Reserved) (Note)
5	NC (Reserved) (Note)
6	GND
7	TALLY1 (red)
8	NC (Reserved) (Note)
9	GND

When GND and pin 2 are shorted, the green tally lamp lights; when GND and pin 7 are shorted, the red tally lamp lights.

(Note) Do not connect anything to the pins marked NC (reserved). Doing so may cause malfunctioning.

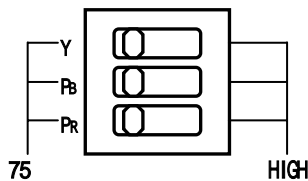
**\*3: Termination selector switch (no. (10))**

Part	Setting	
	Left	Right
Y	Y 75Ω termination	No Y termination
PB	PB 75Ω termination	No PB termination
PR	PR 75Ω termination	No PR termination

As shown in the figure above, the initial setting positions starting with the top one first are left (Y 75Ω termination), left (Pb 75Ω termination) and left (Pr 75Ω termination).

## CHAPTER 3 OPERATION

### 3.1 Connections

This section describes how to connect the WM-3007-T.

#### (1) Connecting the power supply

Check that the monitor's POWER switch is at the OFF position, and connect the Cannon connector of the AC/DC adapter to the WM-3007-T's power socket ((1) on the rear panel view).

Check the shapes of the connector and socket before use.

#### (2) Connecting the input signals

- When SDI signals are to be input:

When SDI signals are to be input, use BNC coaxial cables to make the connections to the SDI IN connectors.

The SDI IN connectors are where the SDI signals are input; MONITOR OUT is an output connector which is used for the simplified monitoring of the SDI input signals.

Supply serial input signals complying with the BTA S-004B standard as the HD-SDI input signals. Use a coaxial cable (5C-FB or its equivalent) which can handle the 1.5 GHz band.

Supply serial input signals complying with the SMPTE 259M (270 Mbps) standard as the SD-SDI input signals.

- When HD analog signals are to be input:

When HD analog signals are to be input, input the YPbPr (or GBR) signals to the respective analog connectors.

Input YPbPr (or GBR) signals complying with the BTA S-001B standard as the HD analog input signals.

Synchronization is obtained from the Y (or G) signal.

Only analog input signals complying with the HDTV standards are acceptable.

- Precaution to be observed in the WAVEFORM or VECTOR mode

When the waveforms or vectors of analog signals are to be displayed, noise up to  $\pm 30\text{mV}$  may occur inside the WM-3007-T. Therefore, do not use the monitor for measurements requiring a higher precision.

- Precaution to be observed in the STATUS mode

Since the WM-3007-T employs an 8-bit A/D converter, 00 is always output for the lower 2 bits of the 10 bits displayed in the STATUS mode.

- When the reference signal is to be input:

Input the sync signal to the REF IN connector when the reference signal is to be input.

Set  Reference in the MENU mode.

When SDI signals are input, they are synchronized to the HD tri-level sync signal and NTSC/PAL black burst signal. When analog signals are input, synchronization is supported only when the video signal format and reference signal format match.

## 3.2 Usage

A protective film is attached to the surface of the LCD panel. Peel it off before using the WM-3007-T.

After checking the connections, turn on the power using the POWER switch of the WM-3007-T. The POWER LED lights, and images are displayed.

If the POWER LED fails to light, check the connections again.

To conduct the simplified monitoring of the SDI input signals, use the MONITOR OUT connector.

The analog input signals will not appear on the monitor if no sync signals are contained in the Y (or G) signal. Check the ARIB BTA S-001 and other standards for the levels, etc.

If no input signals are supplied, the image area appears all black, and  NoSignal is displayed in red on the screen.

## 3.3 Concerning the screens

This section describes the displays which appear on the top and bottom screens of the WM-3007-T. A more detailed description of the following modes is given in the sections listed below.

PICTURE1 mode (refer to Section 3.3.1)

PICTURE2 mode (refer to Section 3.3.2)

WAVEFORM mode (refer to Section 3.3.3)

VECTOR mode (refer to Section 3.3.4)

STATUS mode (refer to Section 3.3.5)

AUDIO mode (refer to Section 3.3.6)

Descriptions of the PICTURE3 mode, multi mode, option mode and MENU mode will be skipped since a description of their displays and details are provided in the sections on the above modes.





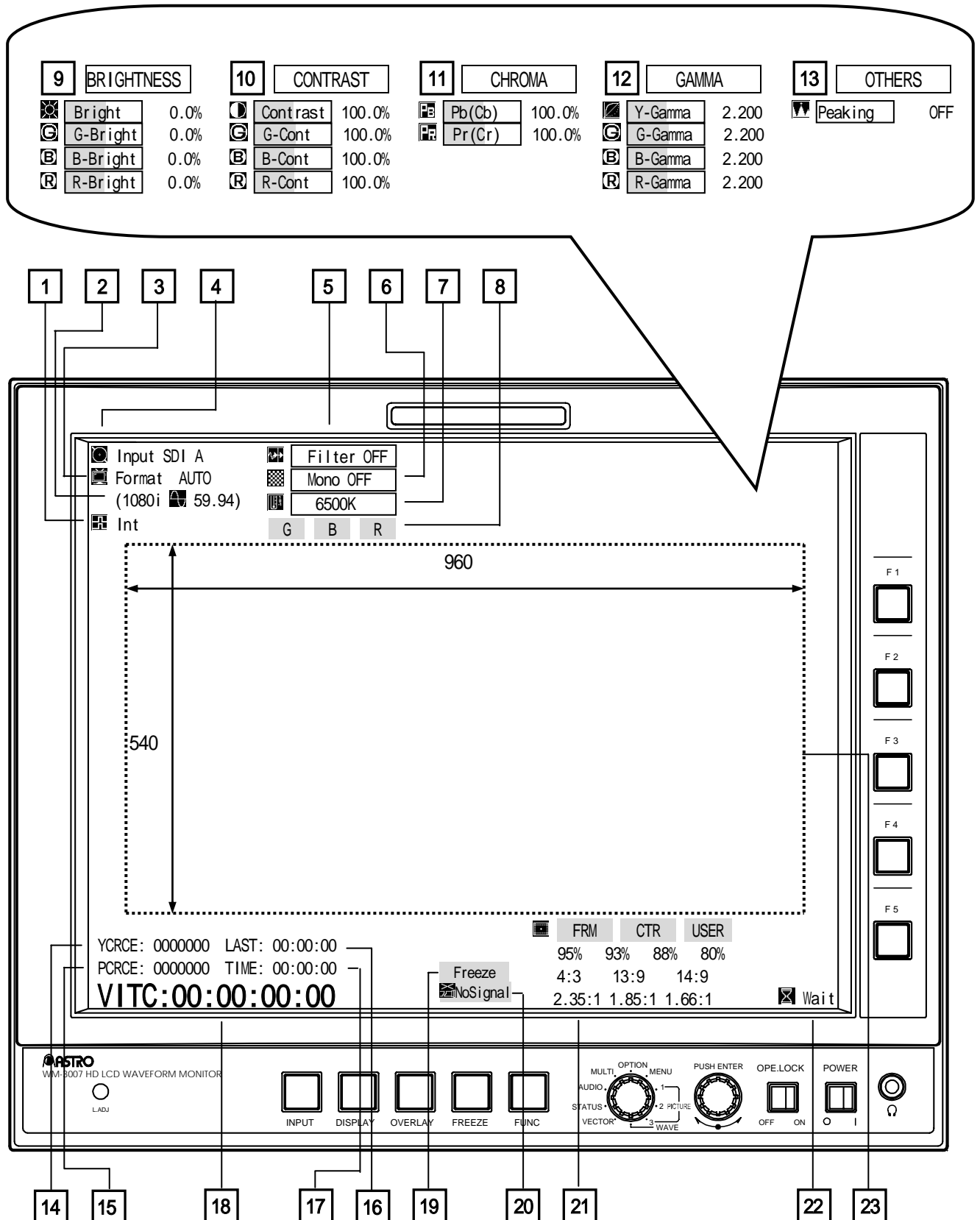



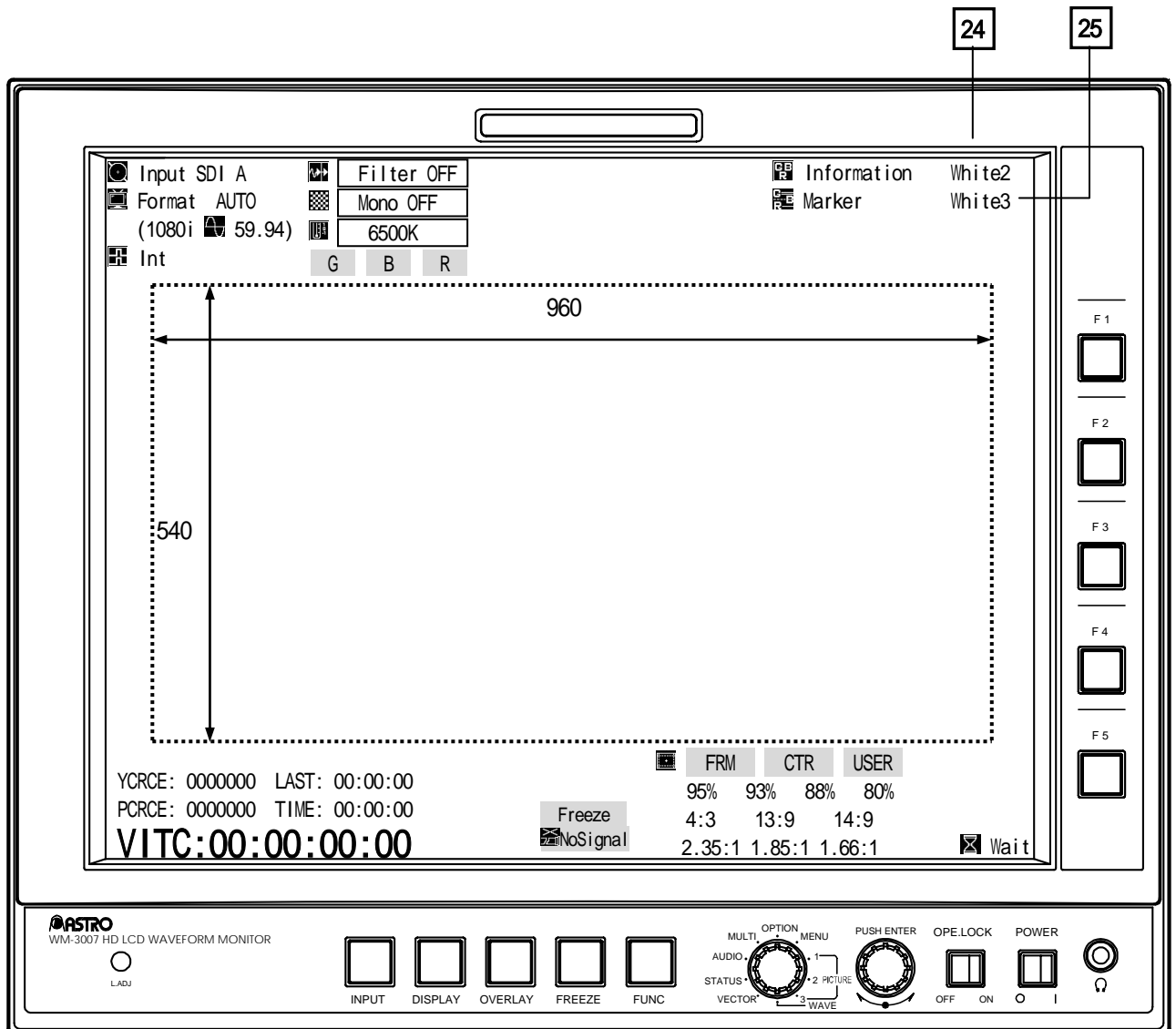





















### 3.3.1 PICTURE1 mode















Regular screen

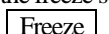

Color setting screen

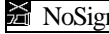

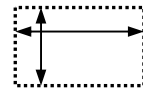
Number	Item	Description	Display modes
1	 (Reference)	The input reference signal is displayed here.  denotes an internal sync signal;  denotes a reference signal (external sync: HD tri-level signal).  denotes a reference signal (external sync: NTSC black burst signal).  denotes a reference signal (external sync: PAL black burst signal).	P1/P2/W/V/S/A/ML/MN
2	 (frequency)	The frequency of the input signals is displayed here. If no signals are input (when NoSignal appears on the screen), "*" is displayed. (For details on the formats, refer to Chapter 4.)	P1/P2/W/V/S/A/ML/MN
3	 Format	The selected format is displayed here. Indicated within the parentheses on the line below are the input signal format and field (or frame) frequency. When analog input has been selected even if 1035i input signals are supplied, these signals will be identified as 1080i signals. If no signals are input (when NoSignal appears on the screen), "*" is displayed. (For details on the formats, refer to Section 4.1.) If no signals are input or if the format which has been set differs from the format of the actual input signals,  <b>Format</b> appears in red.	P1/P2/W/V/S/A/ML/MN
4	 Input	Displayed here is the input channel (SDI A, SDI B or Analog) which has been selected by the INPUT switch.	P1/P2/W/V/S/A/ML/MN
5	 Filter	This indicates ON or OFF as the filter setting.	P1/P2
6	 Mono	This indicates ON or OFF as the monochrome setting.	P1/P2
7	 6500K /  9300K	This indicates the LCD color temperature which has been set.	P1/P2
8	  	These indicate the ON or OFF status each for G, B and R. A highlighted display denotes the ON status.	P1/P2
9	 Bright	This indicates the brightness setting (refer to Section 4.5).	P1
	 G-Bright	This indicates the G brightness setting (refer to Section 4.5).	
	 B-Bright	This indicates the B brightness setting (refer to Section 4.5).	
	 R-Bright	This indicates the R brightness setting (refer to Section 4.5).	
10	 Contrast	This indicates the contrast setting (refer to Section 4.5).	P1
	 G-Cont	This indicates the G contrast setting (refer to Section 4.5).	
	 B-Cont	This indicates the B contrast setting (refer to Section 4.5).	
	 R-Cont	This indicates the R contrast setting (refer to Section 4.5).	
11	 Pb(Cb)	This indicates the Pr (Cb) setting (refer to Section 4.5).	P1
	 Pr(Cr)	This indicates the Pr (Cr) setting (refer to Section 4.5).	
12	 Y-Gamma	This indicates the Y gamma setting (refer to Section 4.5).	P1
	 G-Gamma	This indicates the G gamma setting.	
	 B-Gamma	This indicates the B gamma setting.	
	 R-Gamma	This indicates the R gamma setting.	
13	 Peaking	This indicates the Peaking setting.	P1

Number	Item	Description	Display modes
14		The Y signal is checked for CRC errors, and this is where the number of these errors is displayed. The CRC errors are counted even in the freeze status. When an error is found,  appears in red for one second. Note: The CRC errors are not counted when SD-SDI signals or analog signals are input. Neither are they counted for one second after the input signals have been changed by the INPUT switch.	P1/P2/W/V/S/A/ML/MN
15		The Pb and Pr signals are checked for CRC errors, and this is where the number of these errors is displayed. The CRC errors are counted even in the freeze status. When an error is found,  appears in red for one second. Note: The CRC errors are not counted when SD-SDI signals or analog signals are input. Neither are they counted for one second after the input signals have been changed by the INPUT switch.	P1/P2/W/V/S/A/ML/MN
16		The time elapsed since the last error was found is displayed here.	P1/P2/W/V/S/A/ML/MN
17		The time elapsed after the WM-3007-T was started or error count was reset is displayed here.	P1/P2/W/V/S/A/ML/MN
18		The time code (VITC) is displayed here. It is displayed only when SDI signals are selected. Note: It is displayed accurately when HD-SDI signals are selected, but it may not be displayed accurately in the case of SD-SDI signals.	P1/P2/W/V/S/A/ML/MN
19		This indicates the freeze status. When the freeze status is established,  appears in blue.	P1/P2/P3/W/V/S/A/ML/O/MN
20		 <b>NoSignal</b> appears in red if the input signals are at variance from the set signals.	P1/P2/P3/W/V/S/A/ML/O/MN
21	 (Marker)	Displayed here a list of the usable markers. The currently selected marker is highlighted. <Types of markers> FRAME, CENTER, USER, 95%, 93%, 88%, 80%, 4:3, 13:9, 14:9, 2.35:1, 1.85:1, 1.66:1 Note: When SD-SDI signals are input, the 4:3, 13:9 and 14:9 markers are not displayed even when the marker designations are highlighted. Furthermore, if there are no input signals and AUTO has been selected for the format, the 1080 markers are displayed.	P1/P2
22		This indicates that data is now being saved.	P1/P2/P3/W/V/S/A/ML/O/MN
23		The dotted lines in the diagram represent the picture area. The screen size is normally 960 × 540 pixels. In the case of the 525i/60 format, the size is 720 × 487 pixels whereas in the case of the 625i/50 format, it is 720 × 574 pixels.	
24		This indicates the color of the text.	P1/P2/P3/W/V/S/A/MN
25		This indicates the color of the markers.	P1/P2/P3

Abbreviations used in display mode column:

P1 = PICTURE1 mode, P2 = PICTURE2 mode, P3 = PICTURE3 mode, W = WAVEFORM mode, V = VECTOR mode, S = STATUS mode, A = AUDIO mode, ML = multi mode, O = OPTION mode, and MN = MENU mode.

### 3.3.2 PICTURE2 mode

#### User marker setting screen

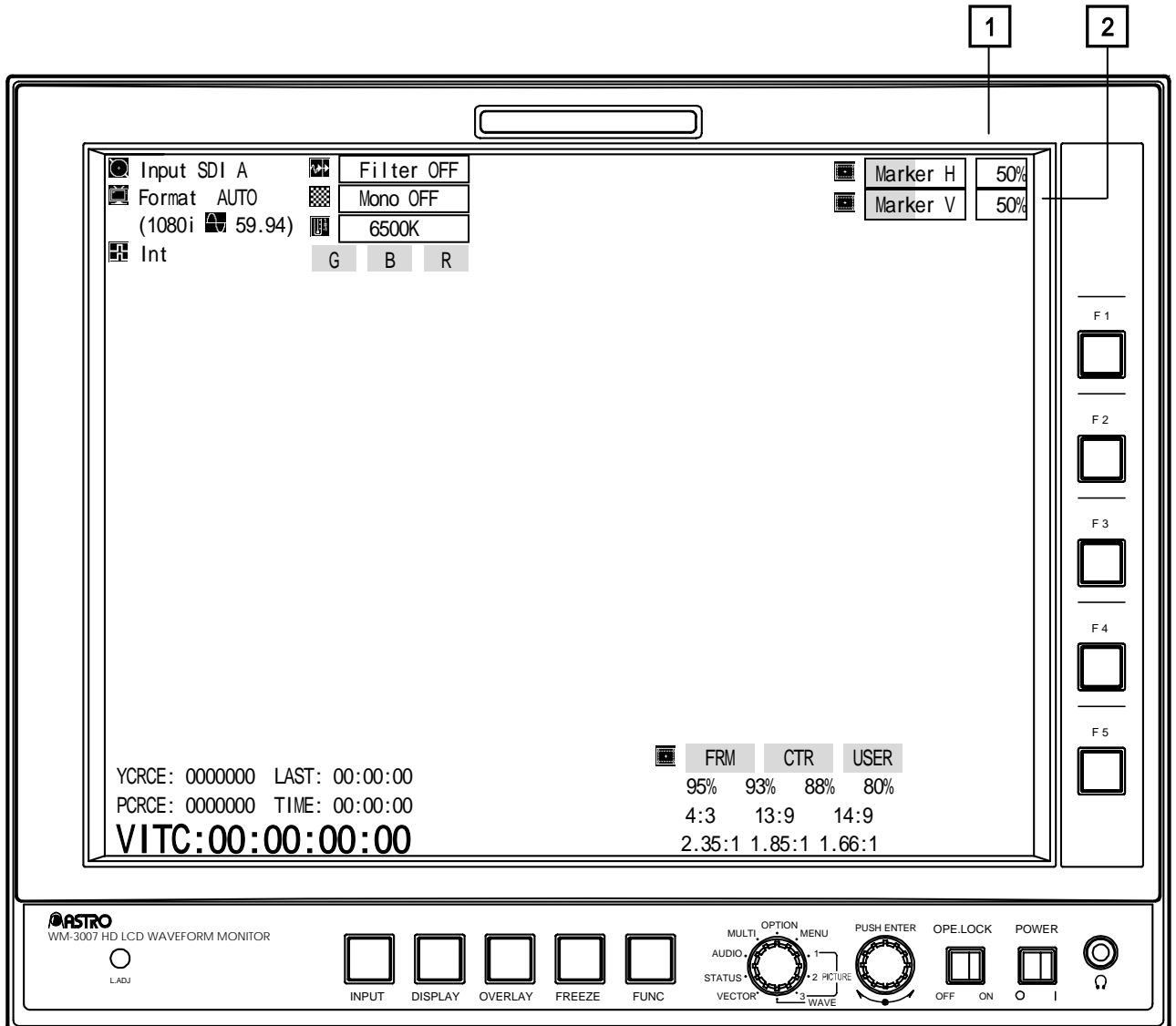

Number	Item	Description	Display modes
1	Marker H	The horizontal setting of the user marker is indicated here.	P2
2	Marker V	The vertical setting of the user marker is indicated here.	P2

Abbreviations used in display mode column:

P1 = PICTURE1 mode, P2 = PICTURE2 mode, P3 = PICTURE3 mode, W = WAVEFORM mode, V = VECTOR mode, S = STATUS mode, A = AUDIO mode, ML = multi mode, O = OPTION mode, and MN = MENU mode.



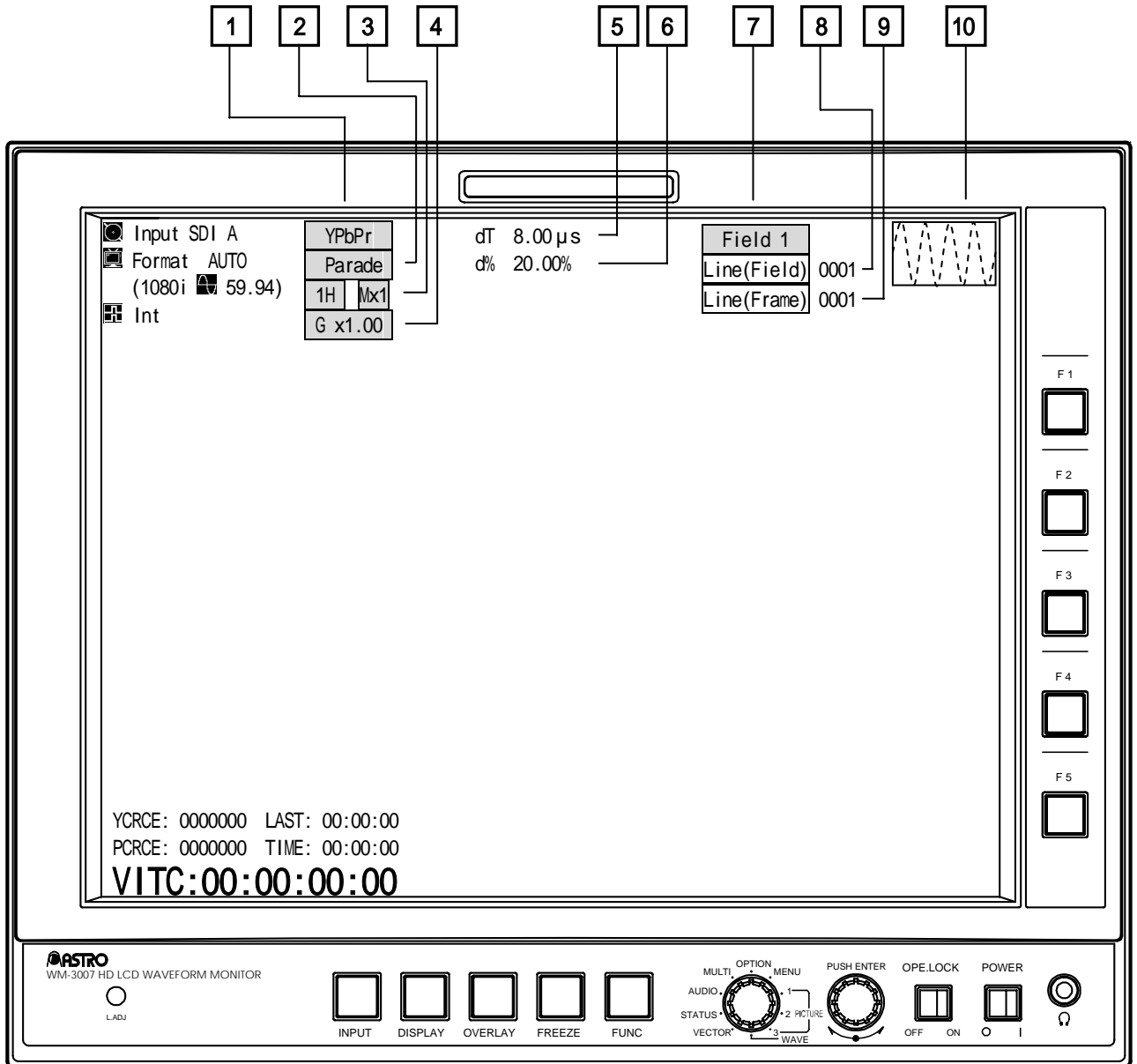

### 3.3.3 WAVEFORM mode

#### Regular screen

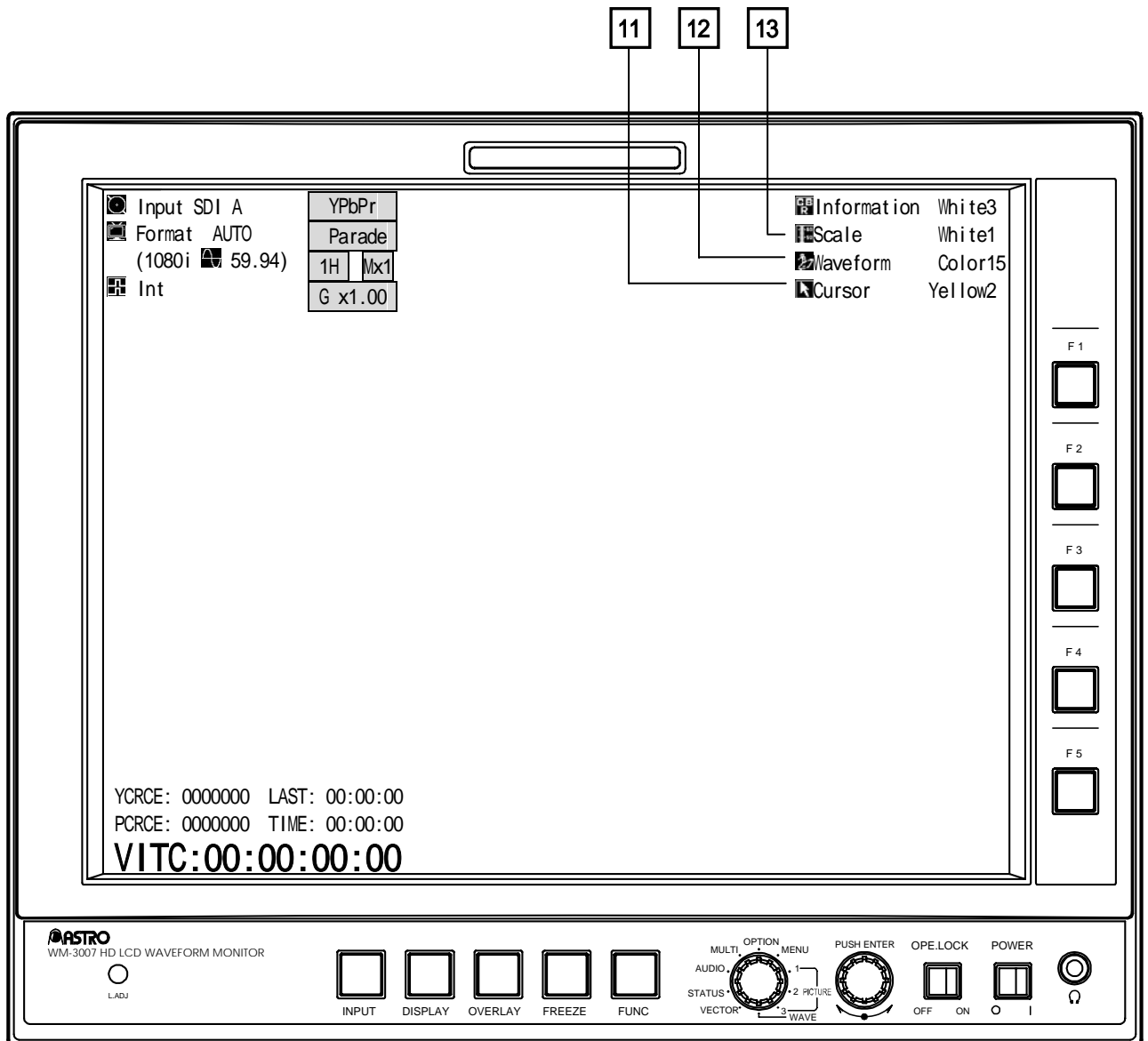

**Color setting screen**



Number	Item	Description	Display modes
1	YPbPr / GBR	This indicates the waveform display method.	W
2	Parade / Overlay	This indicates the parade display or overlay display for the waveforms.	W
3	1H / 2H / 1F / 2F	This indicates the sweep 1H/2H/1F/2F switching.	W
	Mx1 / Mx2 / Mx4	This indicates the MAG magnification rate.	
4	G x*.**	This indicates the GAIN magnification rate.	W
5	dT	This indicates the H cursor difference. It appears when the H cursor is set to ON.	W
6	d% / dV	This indicates the V cursor difference. It appears when the V cursor is set to ON.	W
7	Field 1 / Field 2	This indicates the currently displayed field. It appears when <b>LineSelect</b> is set to ON. It is on the display all the time in the STATUS mode.	W/V/S
8	Line (Field)	This indicates the line number in the currently selected field. It appears when <b>LineSelect</b> is set to ON. It is on the display all the time in the STATUS mode.	W/V/S
9	Line (Frame)	This indicates the line number. It appears when <b>LineSelect</b> is set to ON. It is on the display all the time in the STATUS mode.	W/V/S
10		This indicates the position of the displayed waveform.	W
11	 Cursor	This indicates the color of the cursor.	W/V/S
12	 Waveform	This indicates the color and brightness of the waveforms.	W
13	 Scale	This indicates the color of the scale.	W/V/S/A

Abbreviations used in display mode column:

P1 = PICTURE1 mode, P2 = PICTURE2 mode, P3 = PICTURE3 mode, W = WAVEFORM mode, V = VECTOR mode, S = STATUS mode, A = AUDIO mode, ML = multi mode, O = OPTION mode, and MN = MENU mode.

### 3.3.4 VECTOR mode

#### Regular screen

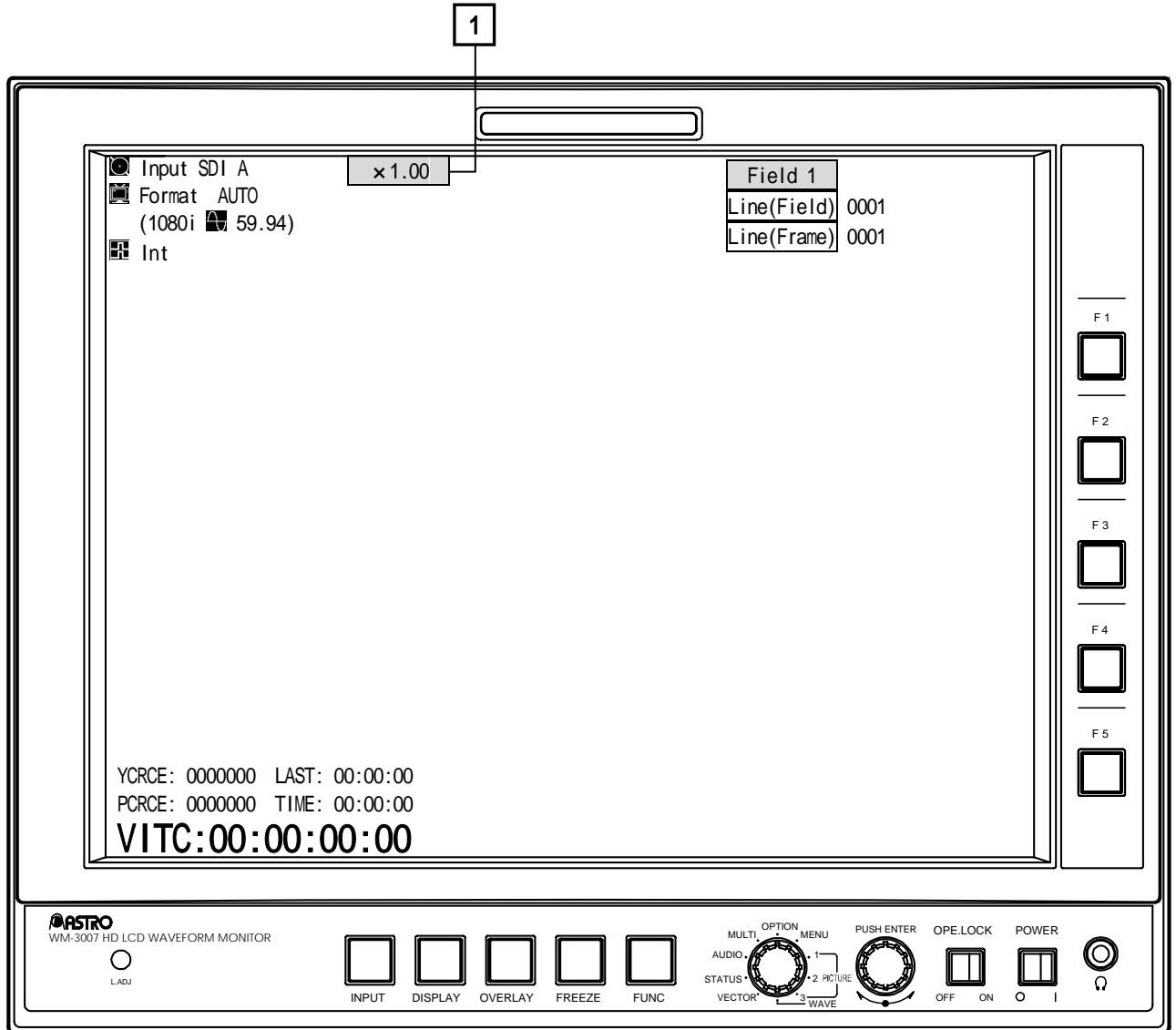

### Color setting screen

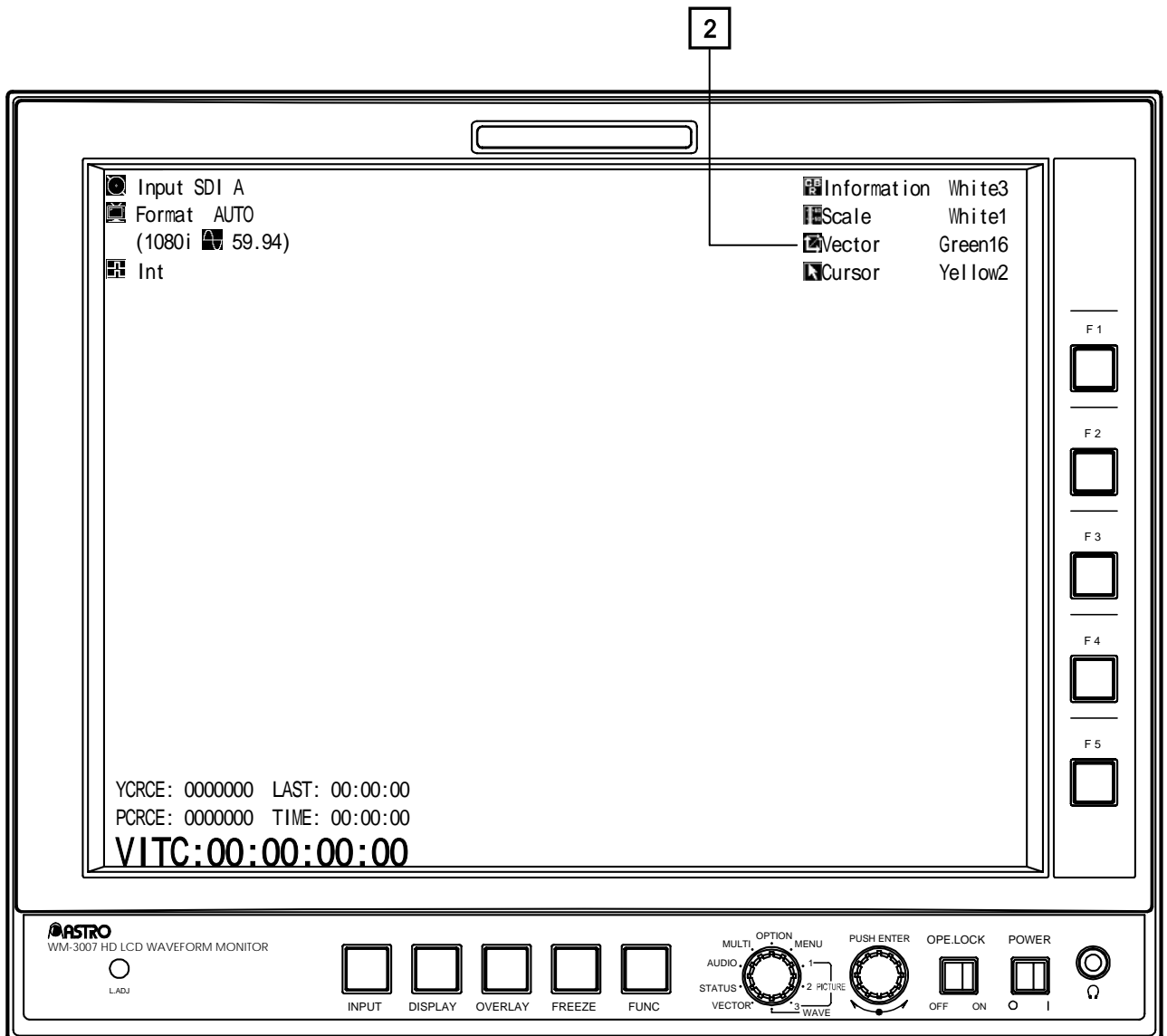

Number	Item	Description	Display modes
1	x *.*	This indicates the GAIN magnification rate.	V
2	Vector	This indicates the color and brightness of the vectors.	V

Abbreviations used in display mode column:

P1 = PICTURE1 mode, P2 = PICTURE2 mode, P3 = PICTURE3 mode, W = WAVEFORM mode, V = VECTOR mode, S = STATUS mode, A = AUDIO mode, ML = multi mode, O = OPTION mode, and MN = MENU mode.

### 3.3.5 STATUS mode

#### Regular screen

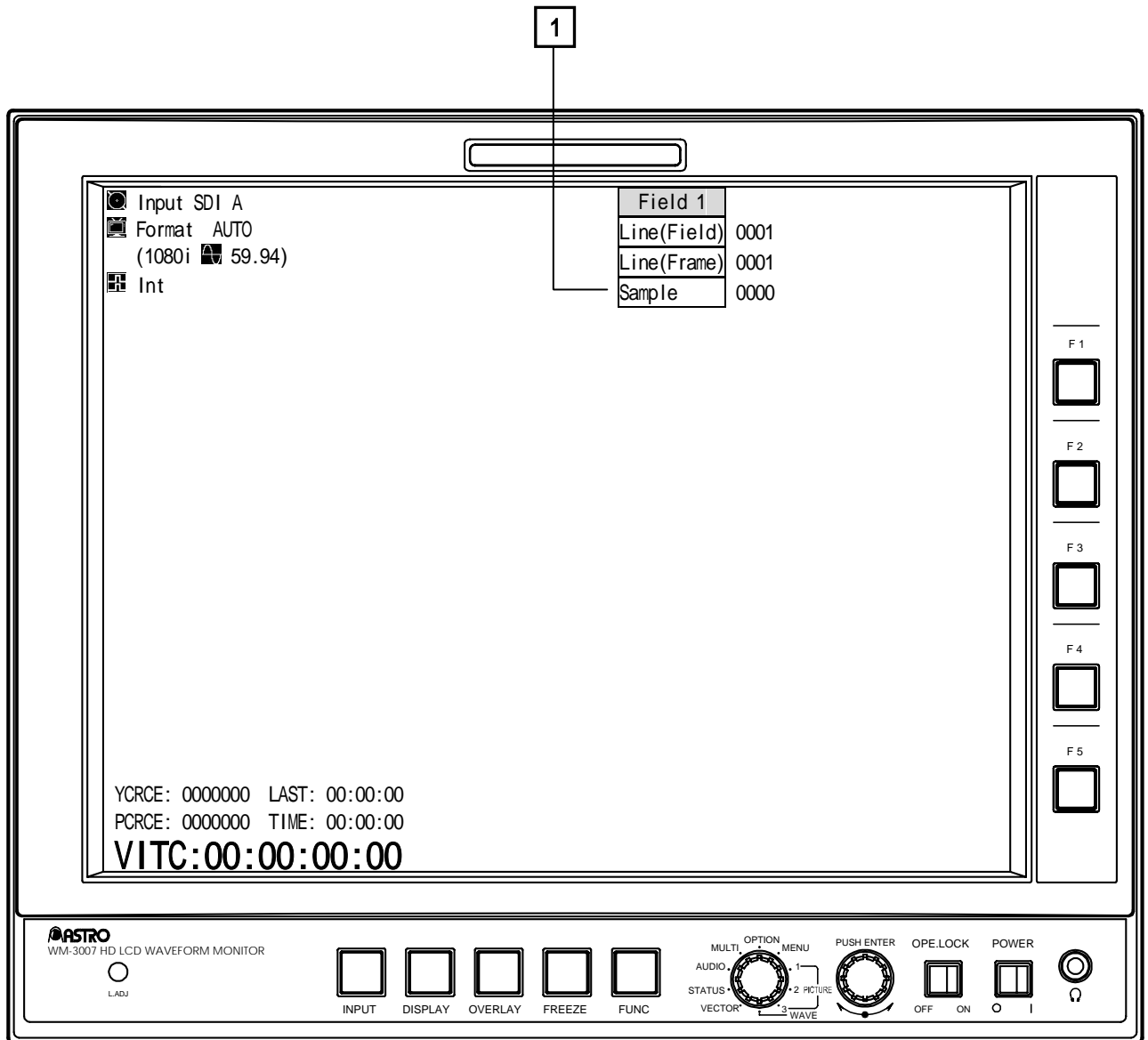

### Color setting screen

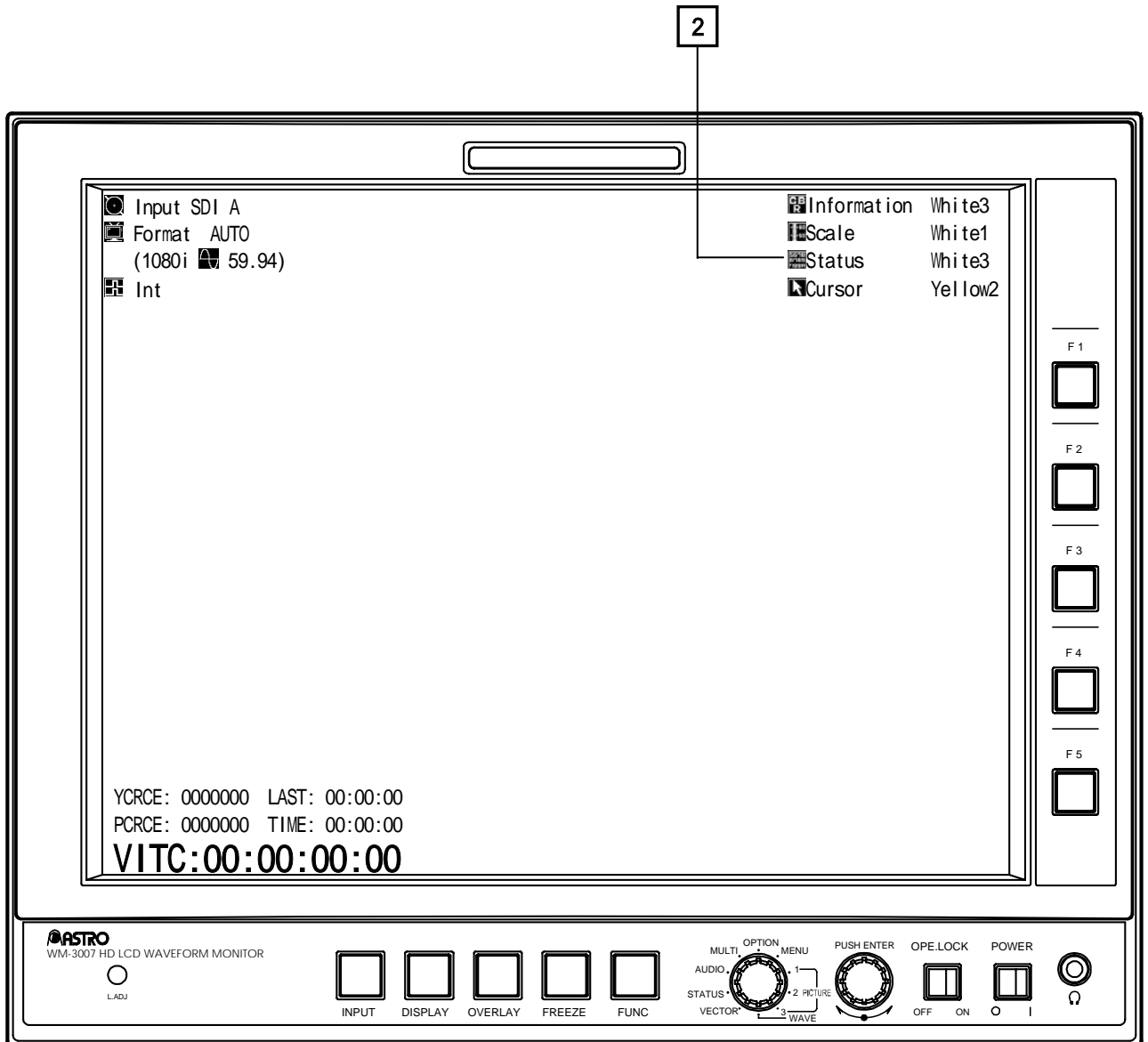

Number	Item	Description	Display modes
1	Sample	This indicates the sample number.	S
2	Status	This indicates the color of the status.	S

Abbreviations used in display mode column:

P1 = PICTURE1 mode, P2 = PICTURE2 mode, P3 = PICTURE3 mode, W = WAVEFORM mode, V = VECTOR mode, S = STATUS mode, A = AUDIO mode, ML = multi mode, O = OPTION mode, and MN = MENU mode.

### 3.3.6 AUDIO mode

#### Audio level meter screen

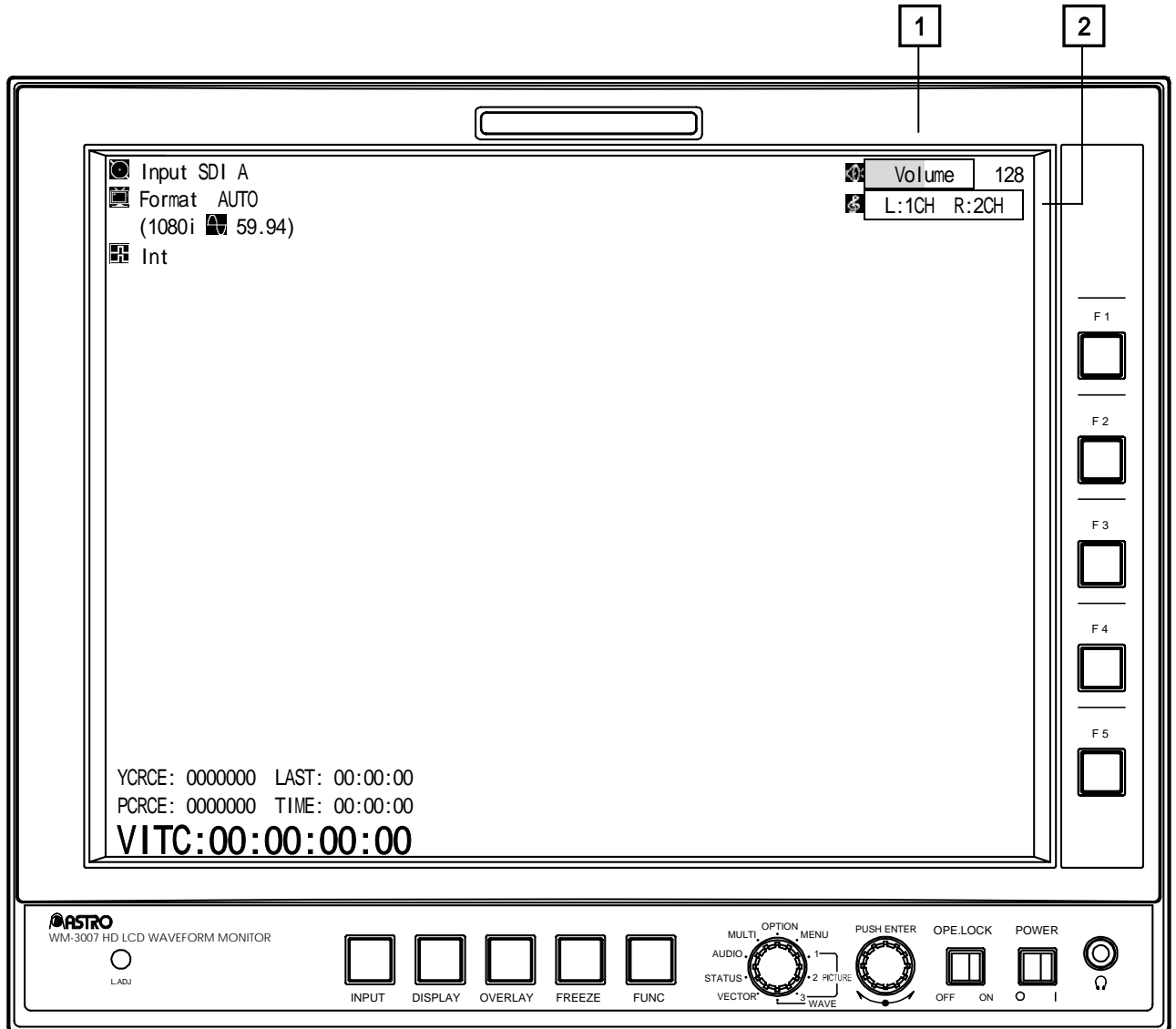

Audio vector screen

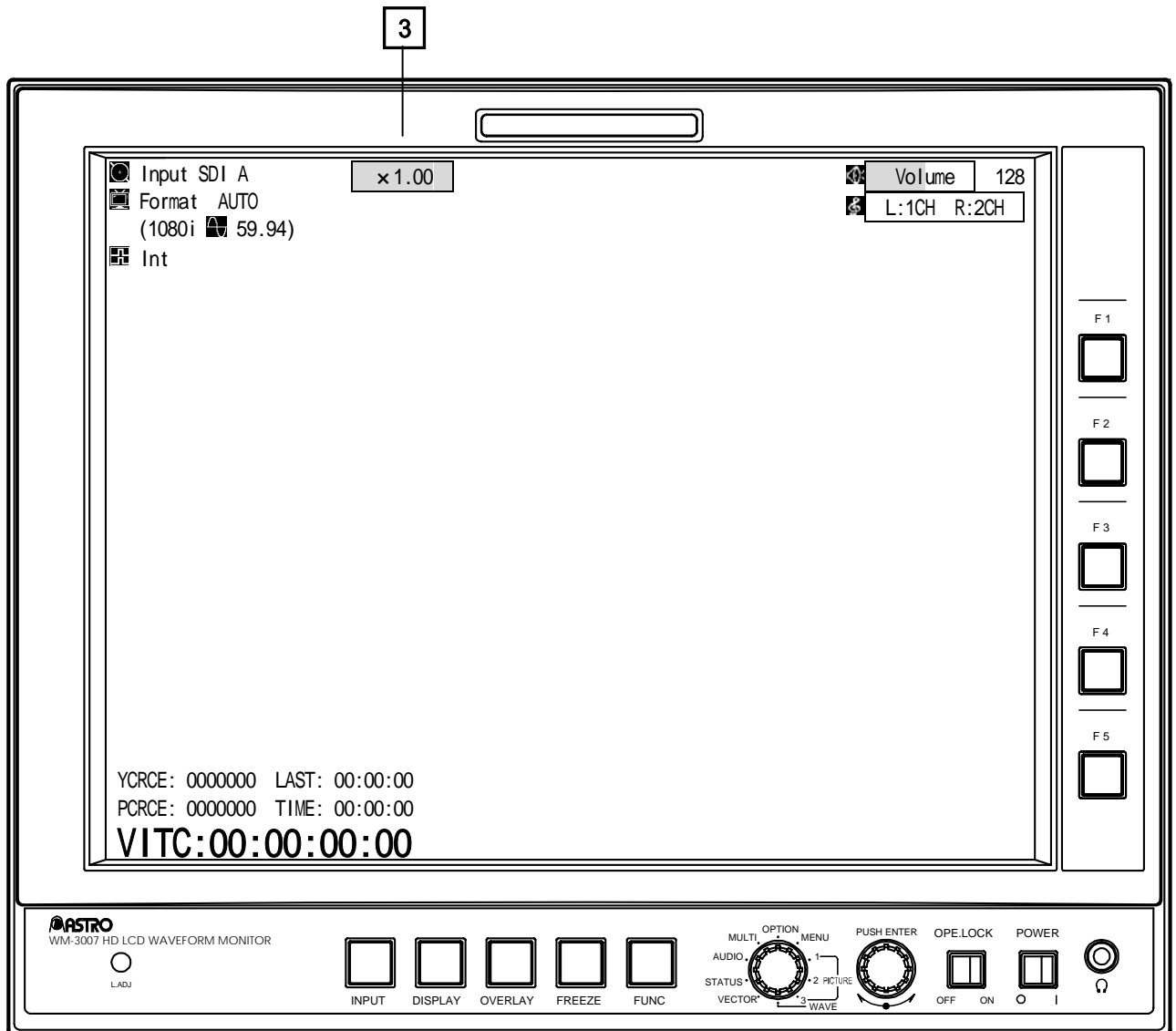

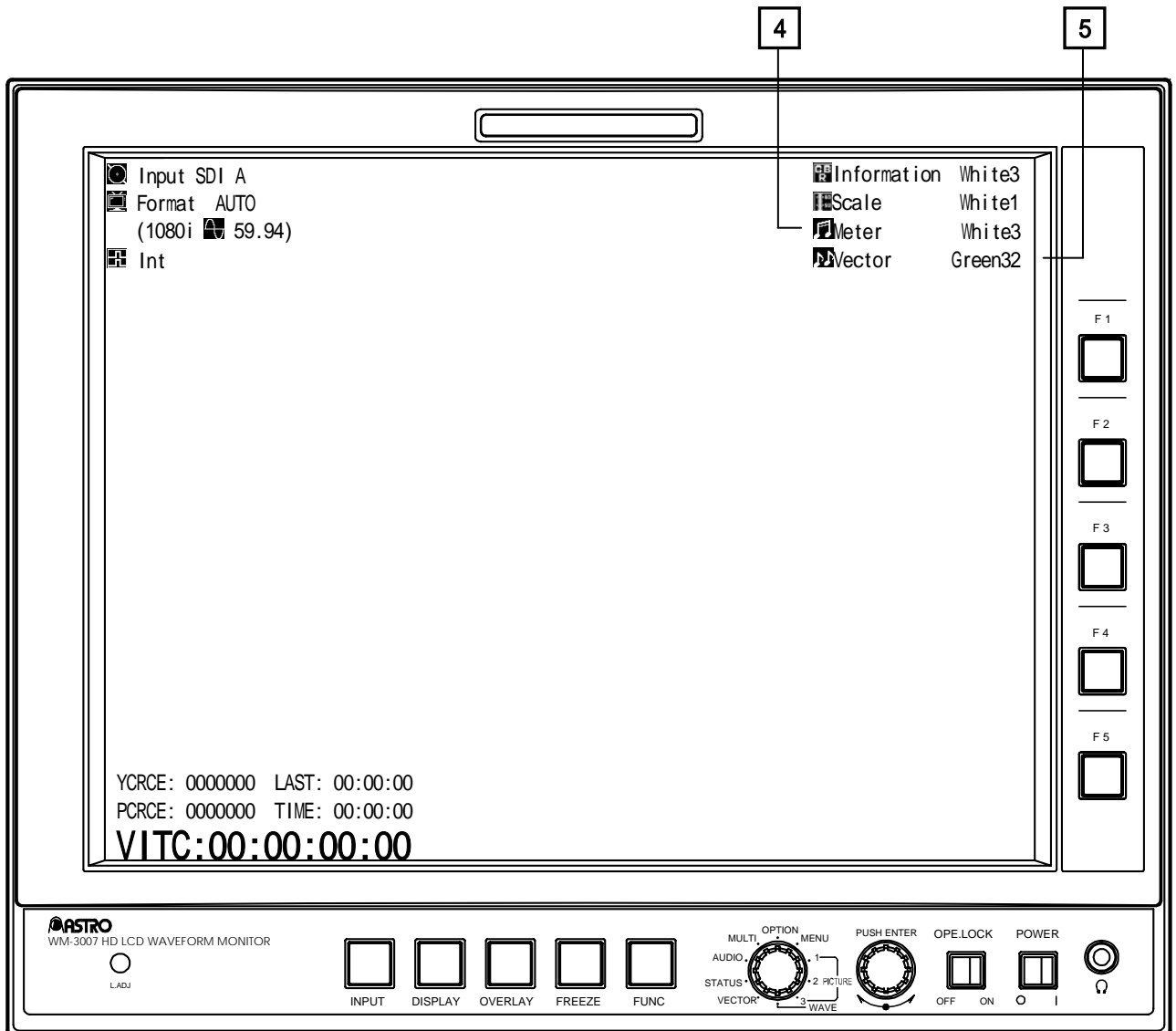
**Color setting screen**

Number	Item	Description	Display modes
1	Volume	This indicates the volume level which is output from the headphone jack.	A
2	L:xCH R:xCH	This indicates the embedded audio channels through which the sound is output from the headphone jack.	A
3	x * . **	This indicates the GAIN magnification rate.	A
4	Meter	This indicates the color of the audio level meter.	A
5	Vector	This indicates the color of the audio vectors.	A

Abbreviations used in display mode column:

P1 = PICTURE1 mode, P2 = PICTURE2 mode, P3 = PICTURE3 mode, W = WAVEFORM mode, V = VECTOR mode, S = STATUS mode, A = AUDIO mode, ML = multi mode, O = OPTION mode, and MN = MENU mode.

### 3.4 Operation

This section describes the WM-3007-T screen displays.

Descriptions of the following modes are given in the sections listed below.

- PICTURE1 mode (refer to Section 3.4.1)
- PICTURE2 mode (refer to Section 3.4.2)
- PICTURE3 mode (refer to Section 3.4.3)
- WAVEFORM mode (refer to Section 3.4.4)
- VECTOR mode (refer to Section 3.4.5)
- STATUS mode (refer to Section 3.4.6)
- AUDIO mode (refer to Section 3.4.7)
- Multi mode (refer to Section 3.4.8)
- Option mode (refer to Section 3.4.9)
- MENU mode (refer to Section 3.4.10)

### 3.4.1 PICTURE1 mode

When the LOCK switch is set to ON and both the FUNC switch and one of the F1 to F5 switches are pressed together, the current settings are saved in the F switch (F1 to F5) concerned.

 Wait appears at the bottom right of the screen while the settings are being saved.

Do not turn off the power during this process. If the power is turned off while the settings are being saved, the initial settings may be saved instead of the settings to be saved.

To load the saved settings, establish the option mode, and press the F switch (F1 to F5) in which the settings were saved.

### 3.4.1.1 Function screen

#### <<Functions>>

The input images can be displayed on this screen.

#### <<Screen>>

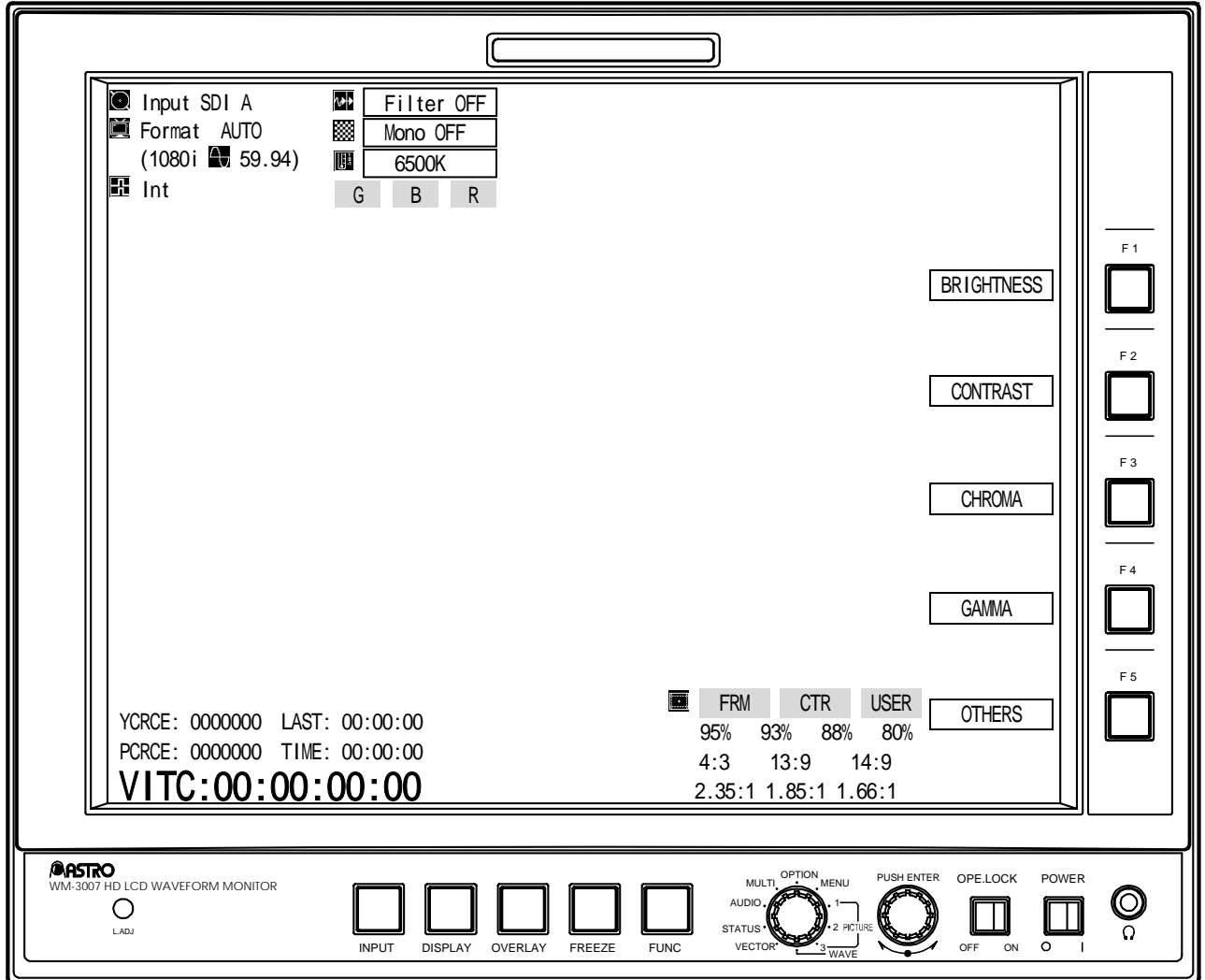

#### [Description of operations]

Switch	Description of function
FUNC switch	Use this to return the display to the previous screen.
F1 switch	<b>BRIGHTNESS</b>
F2 switch	<b>CONTRAST</b>
F3 switch	<b>CHROMA</b>
F4 switch	<b>GAMMA</b>
F5 switch	<b>OTHERS</b>
	Use this to display the peaking, filter and color temperature setting screen. (Refer to Section 3.4.1.6.)

### 3.4.1.2 Brightness setting screen

#### <<Functions>>



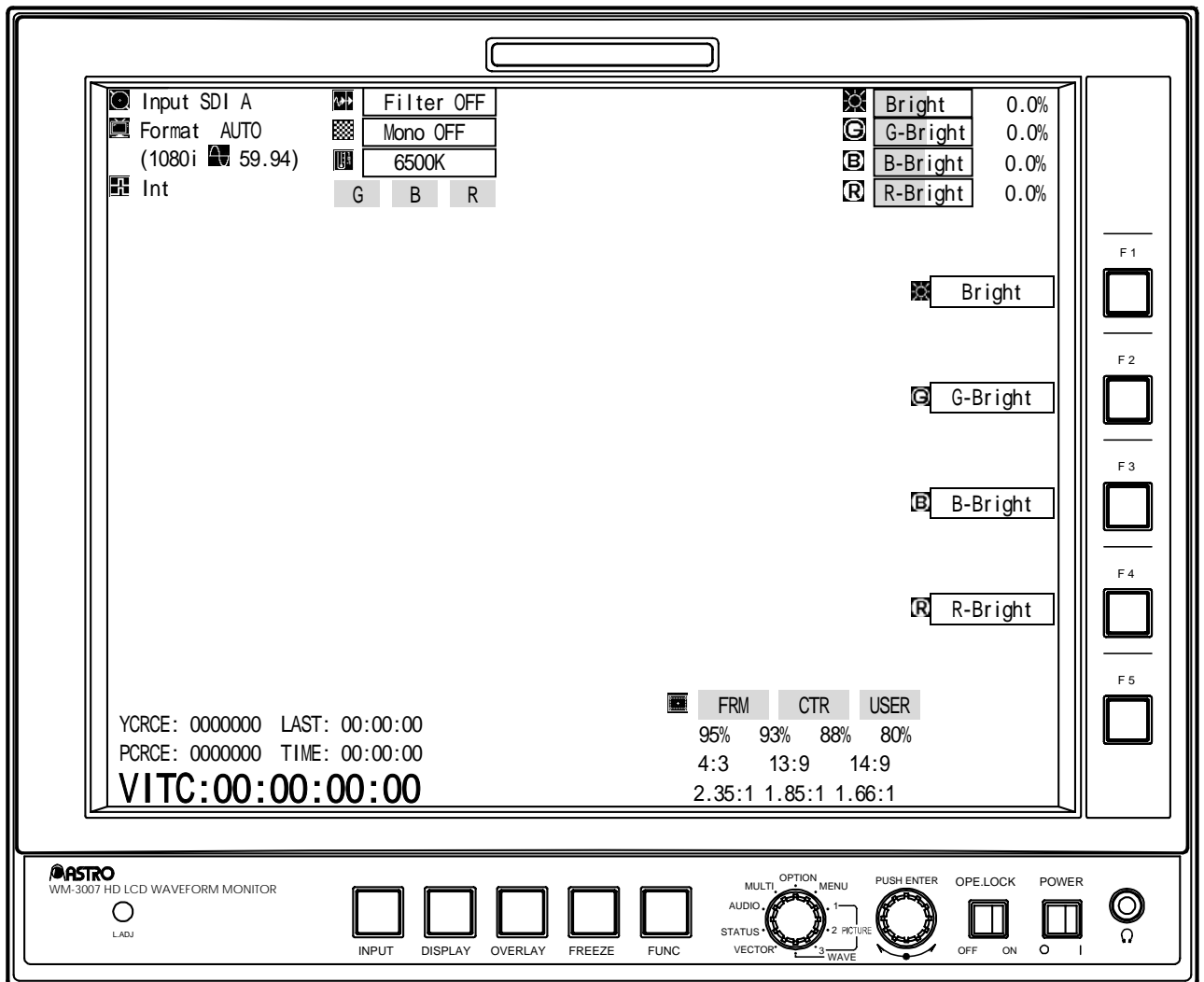

The input images can be displayed so that the following video adjustments can be undertaken.

- Brightness
- G brightness
- B brightness
- R brightness

#### <<Screen>>



**[Description of operations]**

Switch	Description of function
FUNC switch	Use this to return the display to the function screen. (Refer to Section 3.4.1.1.)
F1 switch  Bright	Use this to adjust the brightness level by turning the adjustment dial. (Refer to Section 4.5.) Variable range: -50.00% to +50.00% When the adjustment dial is pressed, the brightness level is restored to the initial value.
F2 switch  G-Bright	Use this to adjust the G brightness level by turning the adjustment dial. (Refer to Section 4.5.) Variable range: -50.00% to +50.00% When the adjustment dial is pressed, the G brightness level is restored to the initial value.
F3 switch  B-Bright	Use this to adjust the B brightness level by turning the adjustment dial. (Refer to Section 4.5.) Variable range: -50.00% to +50.00% When the adjustment dial is pressed, the B brightness level is restored to the initial value.
F4 switch  R-Bright	Use this to adjust the R brightness level by turning the adjustment dial. (Refer to Section 4.5.) Variable range: -50.00% to +50.00% When the adjustment dial is pressed, the R brightness level is restored to the initial value.
F5 switch	(Not used)

### 3.4.1.3 Contrast setting screen

#### <<Functions>>

The input images can be displayed so that the following video adjustments can be undertaken.

- Contrast
- G contrast
- B contrast
- R contrast

#### <<Screen>>

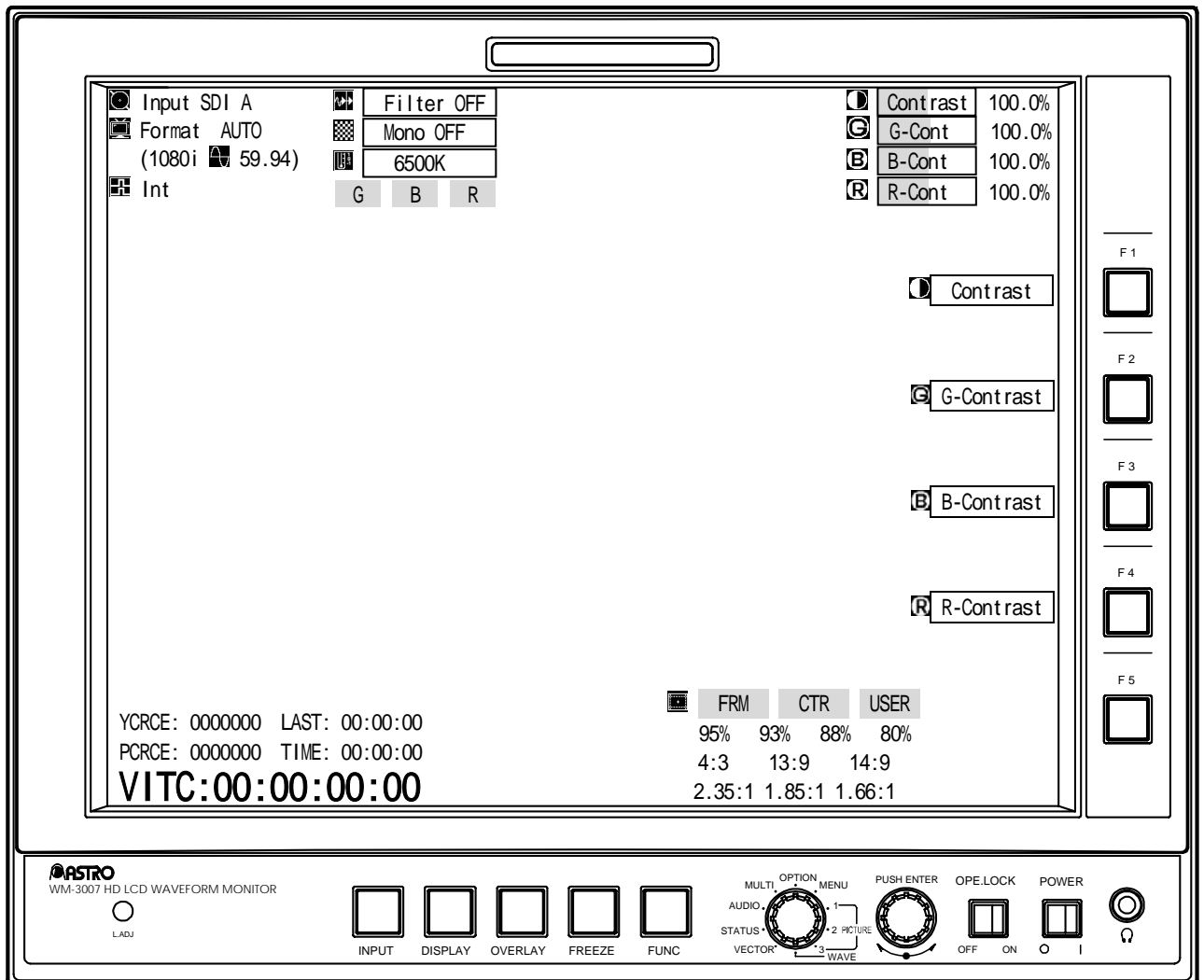

**[Description of operations]**

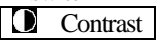
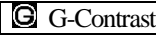
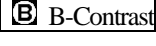
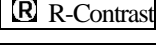
Switch	Description of function
FUNC switch	Use this to return the display to the function screen. (Refer to Section 3.4.1.1.)
F1 switch  Contrast	Use this to adjust the contrast level by turning the adjustment dial. (Refer to Section 4.5.) Variable range: 0.0% to 200.0% When the adjustment dial is pressed, the contrast level is restored to the initial value.
F2 switch  G-Contrast	Use this to adjust the G contrast level by turning the adjustment dial. (Refer to Section 4.5.) Variable range: 0.0% to 200.0% When the adjustment dial is pressed, the G contrast level is restored to the initial value.
F3 switch  B-Contrast	Use this to adjust the B contrast level by turning the adjustment dial. (Refer to Section 4.5.) Variable range: 0.0% to 200.0% When the adjustment dial is pressed, the B contrast level is restored to the initial value.
F4 switch  R-Contrast	Use this to adjust the R contrast level by turning the adjustment dial. (Refer to Section 4.5.) Variable range: 0.0% to 200.0% When the adjustment dial is pressed, the R contrast level is restored to the initial value.
F5 switch	(Not used)

### 3.4.1.4 Chroma setting screen

#### <<Functions>>



The input images can be displayed so that the following video adjustments can be undertaken.

- Pb(Cb)
- Pr(Cr)

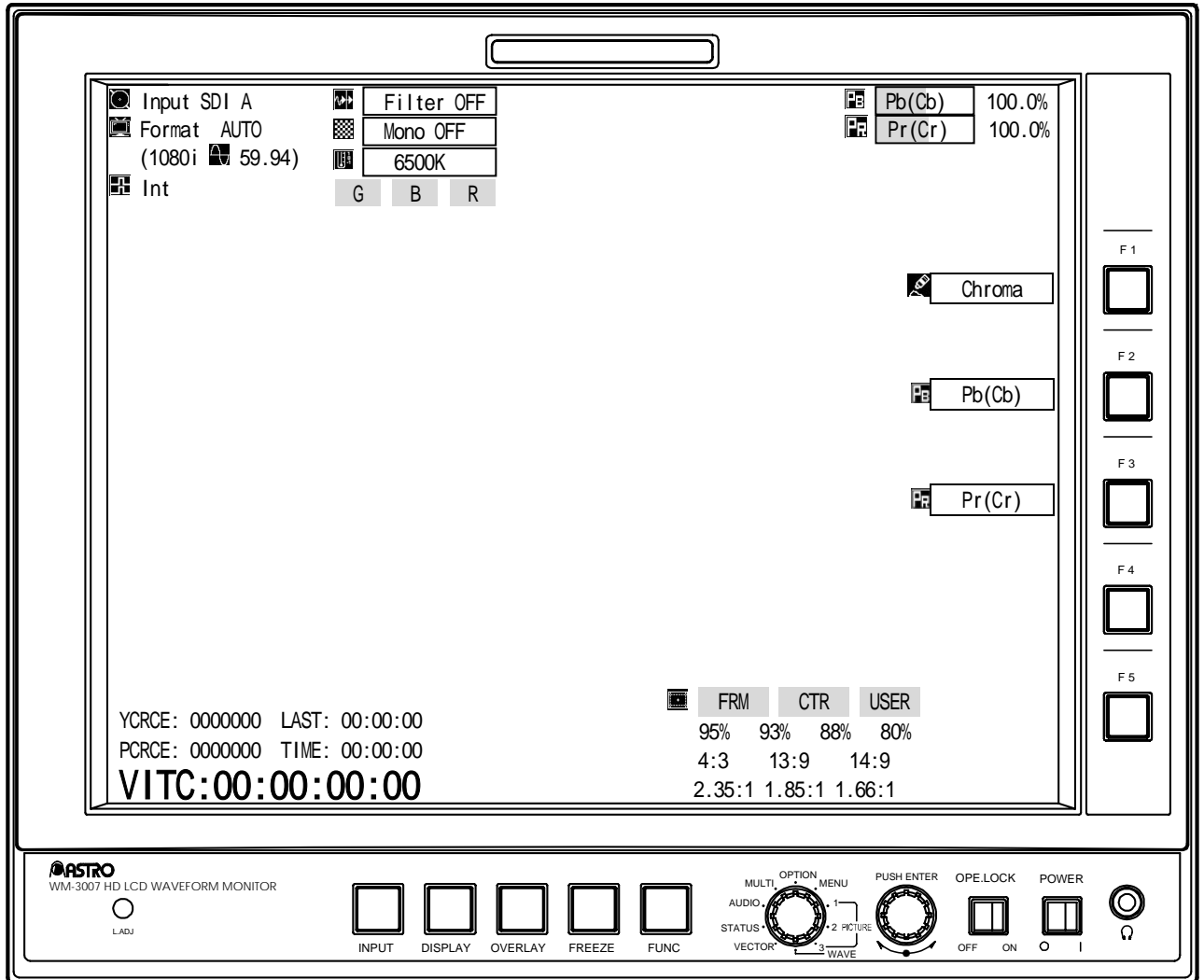
#### <<Screen>>



**[Description of operations]**

Switch	Description of function
FUNC switch	Use this to return the display to the function screen. (Refer to Section 3.4.1.1.)
F1 switch  Chroma	Use this to adjust the chroma level by turning the adjustment dial. (Refer to Section 4.5.) Variable range: 0.0% to 200.0% When the adjustment dial is pressed, the chroma level is restored to the initial value.
F2 switch  Pb(Cb)	Use this to adjust the Pb (Cb) level by turning the adjustment dial. (Refer to Section 4.5.) Variable range: 0.0% to 200.0% When the adjustment dial is pressed, the Pb (Cb) level is restored to the initial value.
F3 switch  Pr(Cr)	Use this to adjust the Pb (Cr) level by turning the adjustment dial. (Refer to Section 4.5.) Variable range: 0.0% to 200.0% When the adjustment dial is pressed, the Pb (Cr) level is restored to the initial value.
F4 switch	(Not used)
F5 switch	(Not used)



If, when the Pb and Pr values differ while the chroma levels are adjusted, either of the chroma levels reaches an adjustment value of 200% or 0%, no further adjustment is possible.

### 3.4.1.5 Gamma setting screen

#### <<Functions>>



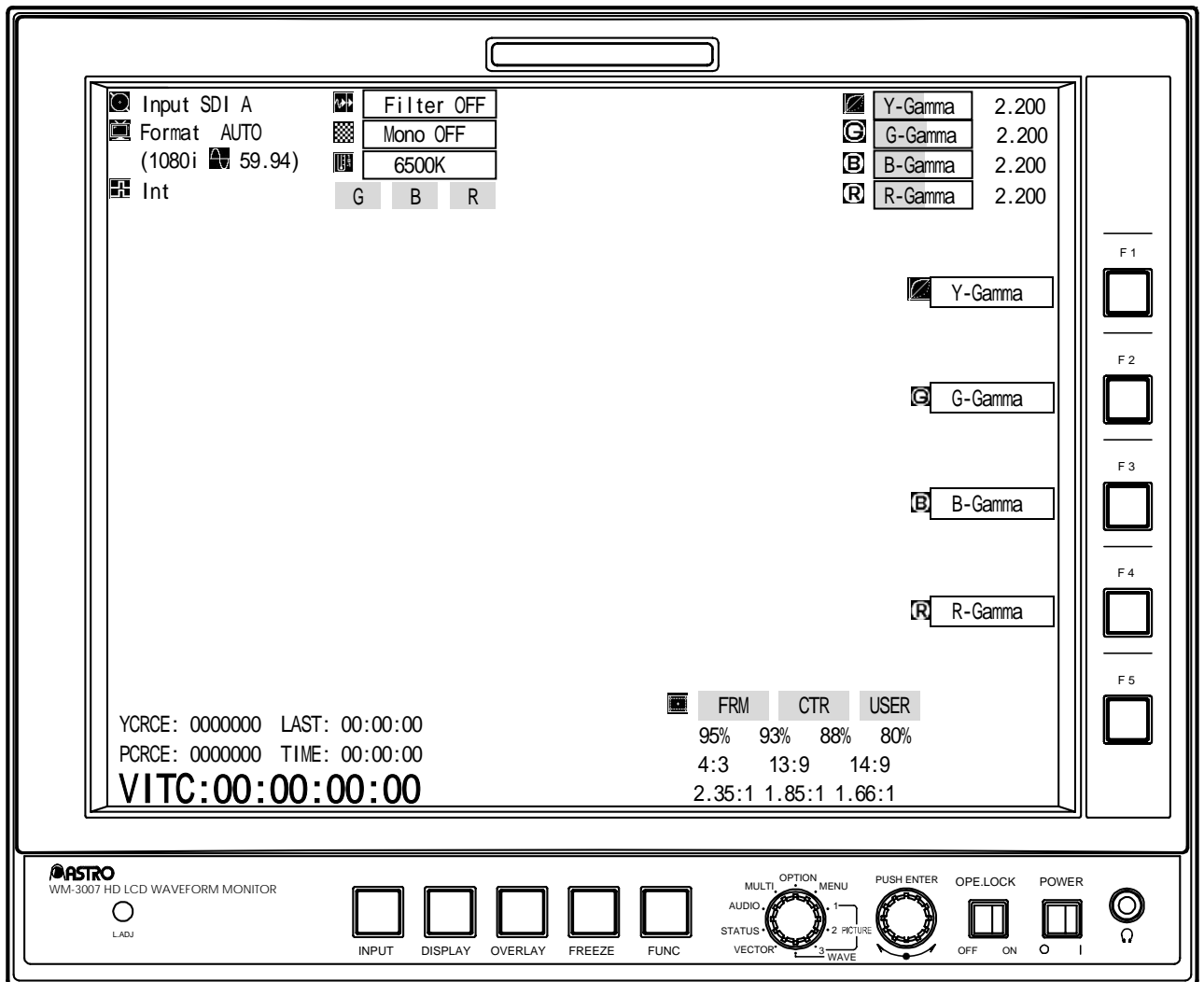

The input images can be displayed so that the following video adjustments can be undertaken.

- Y gamma
- G gamma
- B gamma
- R gamma

#### <<Screen>>



**[Description of operations]**

Switch	Description of function
FUNC switch	Use this to return the display to the function screen. (Refer to Section 3.4.1.1.)
F1 switch  Y-Gamma	Use this to adjust the Y gamma level by turning the adjustment dial. (Refer to Section 4.5.) Variable range: 1.100 to 4.400 When the adjustment dial is pressed, the Y gamma level is restored to the initial value.
F2 switch  G-Gamma	Use this to adjust the G gamma level by turning the adjustment dial. (Refer to Section 4.5.) Variable range: 1.100 to 4.400 When the adjustment dial is pressed, the G gamma level is restored to the initial value.
F3 switch  B-Gamma	Use this to adjust the B gamma level by turning the adjustment dial. (Refer to Section 4.5.) Variable range: 1.100 to 4.400 When the adjustment dial is pressed, the B gamma level is restored to the initial value.
F4 switch  R-Gamma	Use this to adjust the R gamma level by turning the adjustment dial. (Refer to Section 4.5.) Variable range: 1.100 to 4.400 When the adjustment dial is pressed, the R gamma level is restored to the initial value.
F5 switch	(Not used)

### 3.4.1.6 Other video setting screen

#### <<Functions>>



The input images can be displayed so that the following video adjustments can be undertaken.

- Peaking
- Filter
- Color temperature

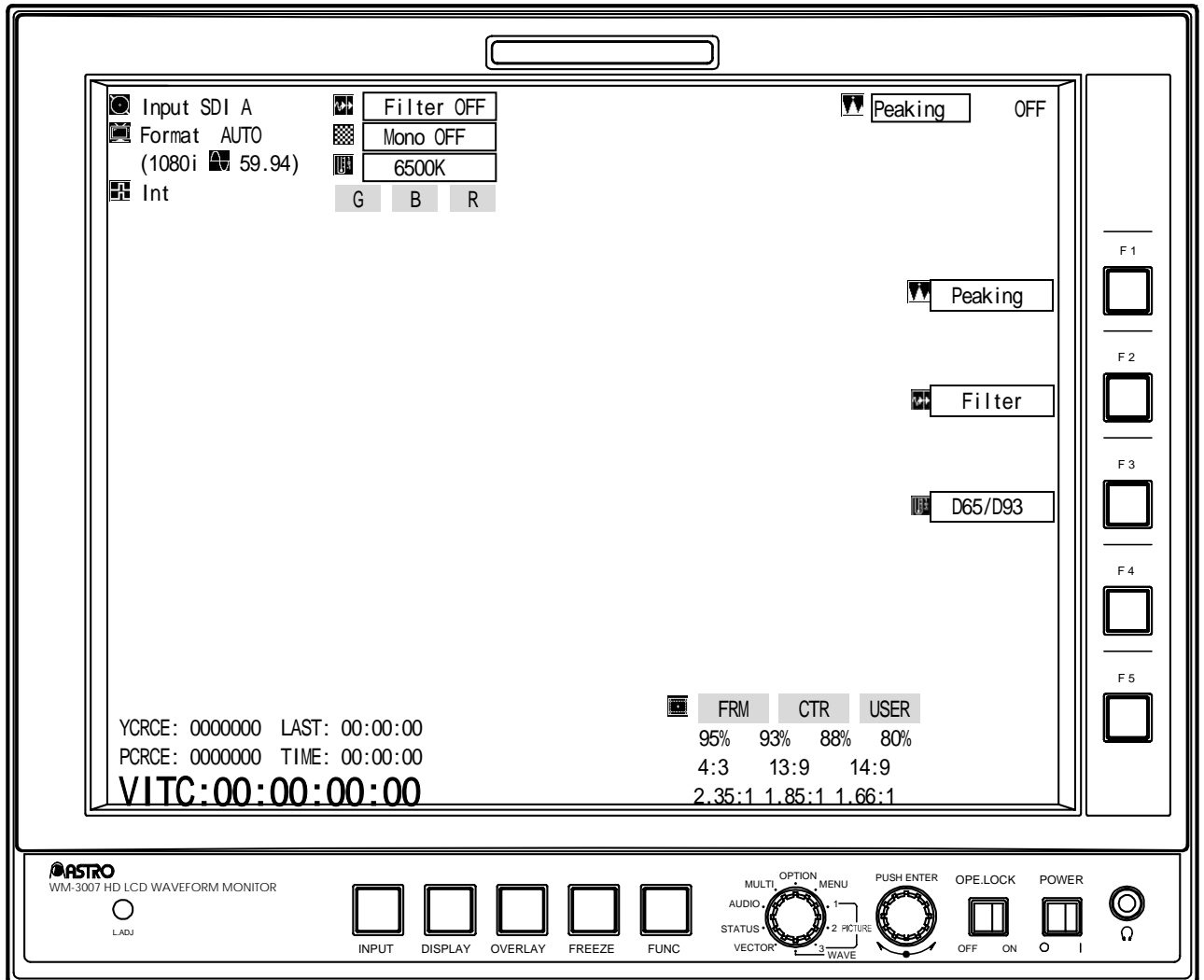
#### <<Screen>>



**[Description of operations]**

Switch	Description of function
FUNC switch	Use this to return the display to the function screen. (Refer to Section 3.4.1.1.)
F1 switch  Peaking	Use this to adjust the peaking level by turning the adjustment dial. Variable range: OFF, ON (1 to 100) When the adjustment dial is pressed, the peaking level is restored to the initial value.
F2 switch  Filter	Use this to select ON or OFF for the filter.
F3 switch  D65/D93	Use this to select 6500K or 9300K for the color temperature.
F4 switch	(Not used)
F5 switch	(Not used)



Peaking is reset to OFF when Filter is set to ON. Conversely, Filter is reset to OFF when Peaking is set to ON.

### 3.4.1.7 Color setting screen

#### <<Functions>>



By holding down the OVERLAY switch in the PICTURE1 mode, the input images can be displayed so that the following settings can be performed.

- Text color
- Marker color

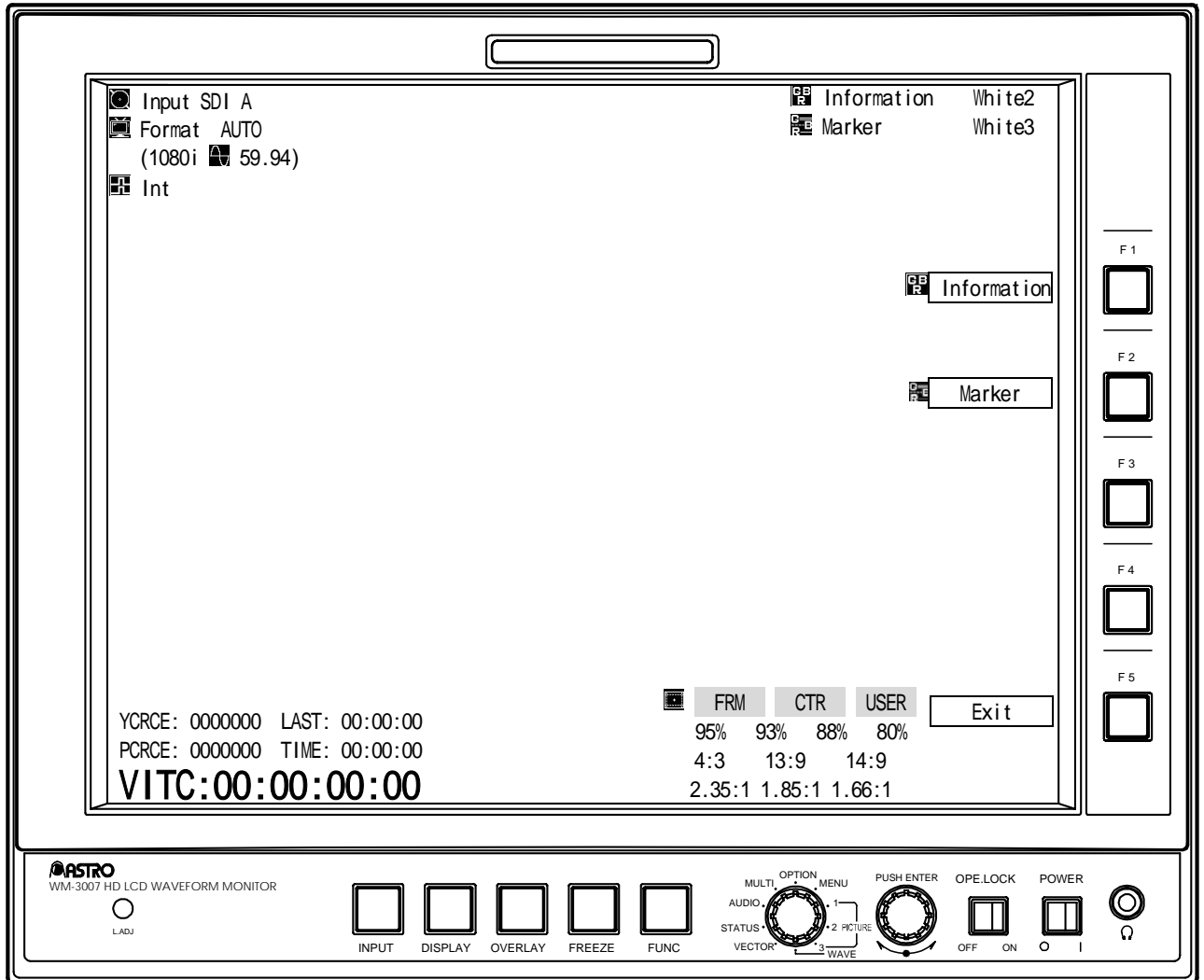
#### <<Color setting screen>>



**[Description of operations]**

Switch	Description of function
FUNC switch	Use this to return the display to the previous screen.
F1 switch  Information	Use this to select the color of the text (from 63 colors) by turning the adjustment dial. When the adjustment dial is pressed, the text color is restored to the initial value.
F2 switch  Marker	Use this to select the color of the markers (from 64 colors) by turning the adjustment dial. When the adjustment dial is pressed, the marker color is restored to the initial value.
F3 switch	(Not used)
F4 switch	(Not used)
F5 switch  Exit	Use this to return the display to the previous screen.
OVERLAY switch	When this is held down, the display is returned to the previous screen.

**3.4.2 PICTURE2 mode**

When the LOCK switch is set to ON and both the FUNC switch and one of the F1 to F5 switches are pressed together, the current settings are saved in the F switch (F1 to F5) concerned.

 Wait appears at the bottom right of the screen while the settings are being saved.

Do not turn off the power during this process. If the power is turned off while the settings are being saved, the initial settings may be saved instead of the settings to be saved.

To load the saved settings, establish the option mode, and press the F switch (F1 to F5) in which the settings were saved.

### 3.4.2.1 Regular screen

#### <<Functions>>

The input images can be displayed so that the following settings can be performed.

- Monochrome
- ON/OFF for G, B, R
- Markers



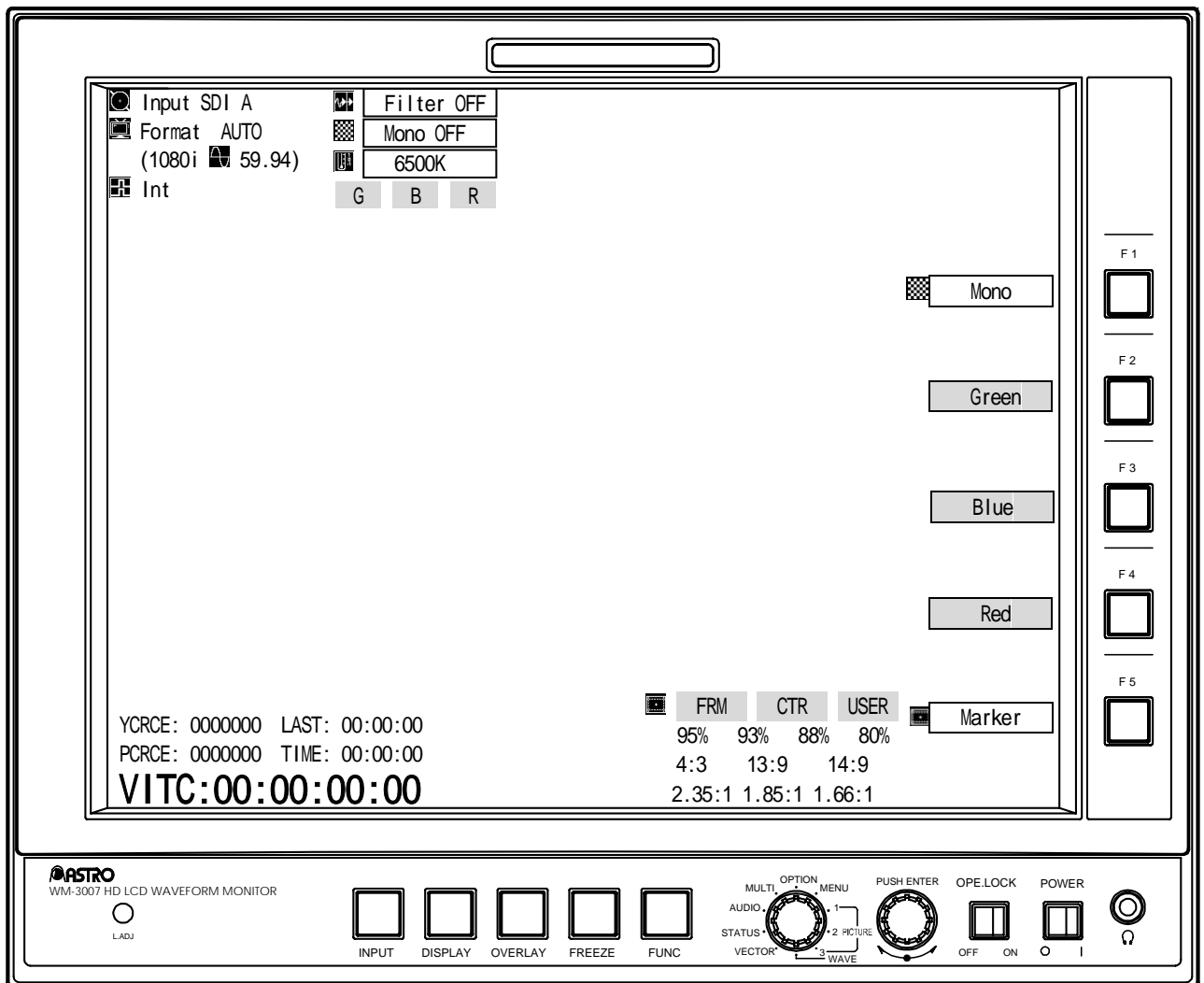

Note: With the 525i/60 and 625i/50 formats, the 4:3, 13:9 and 14:9 markers are not displayed.

Furthermore, if there are no input signals and **AUTO** has been selected for the format, the 1080 markers are displayed.

#### <<Screen>>



**[Description of operations]**

Switch	Description of function
FUNC switch	(Not used)
F1 switch  Mono	Use this to set monochrome to ON or OFF. When monochrome is set to ON, Green, Blue and Red are set to ON.
F2 switch  Green	Use this to switch between displaying and not displaying the Green signals of the input images. When Green is set to OFF while monochrome is ON, monochrome will be set to OFF.
F3 switch  Blue	Use this to switch between displaying and not displaying the Blue signals of the input images. When Blue is set to OFF while monochrome is ON, monochrome will be set to OFF.
F4 switch  Red	Use this to switch between displaying and not displaying the Red signals of the input images. When Red is set to OFF while monochrome is ON, monochrome will be set to OFF.
F5 switch  Marker	Use this to set the markers to ON or OFF. At the marker ON setting, select the markers using the adjustment dial, and enter the selection by pressing the adjustment dial. Note: With the 525i/60 and 625i/50 formats, the 4:3, 13:9 and 14:9 markers are not displayed. Furthermore, if there are no input signals and "AUTO" has been selected for the format, the 1080 markers are displayed.

### 3.4.2.2 User marker setting screen

#### <<Functions>>

When the F5 switch (Marker switch) is held down in the PICTURE2 mode, the input images are displayed so that the horizontal and vertical values of the user markers can be set.

#### <<Screen>>

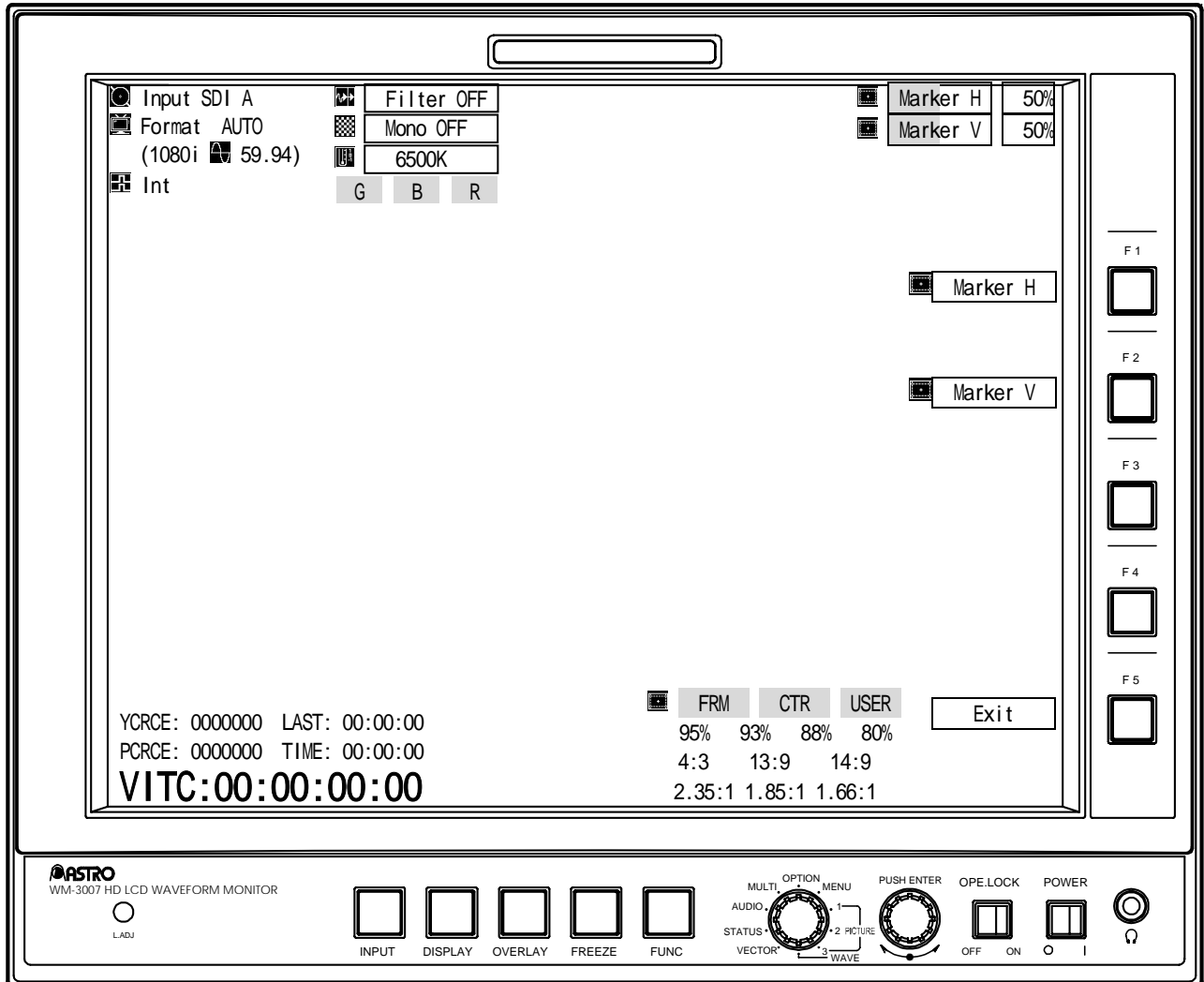

#### [Description of operations]

Switch	Description of function
FUNC switch	Use this to return the display to the regular screen. (Refer to Section 3.4.2.1.)
F1 switch Marker H	Use this to adjust the horizontal marker value by turning the adjustment dial. When the adjustment dial is pressed, the horizontal marker value is restored to the initial value. Variable range: 0 to 99%
F2 switch Marker V	Use this to adjust the vertical marker value by turning the adjustment dial. When the adjustment dial is pressed, the vertical marker value is restored to the initial value. Variable range: 0 to 99%
F3 switch	(Not used)
F4 switch	(Not used)
F5 switch Exit	Use this to return the display to the regular screen. (Refer to Section 3.4.2.1.)

### 3.4.2.3 Color setting screen

#### <<Functions>>



By holding down the OVERLAY switch in the PICTURE2 mode, the input images can be displayed so that the following settings can be performed.

- Text color
- Marker color

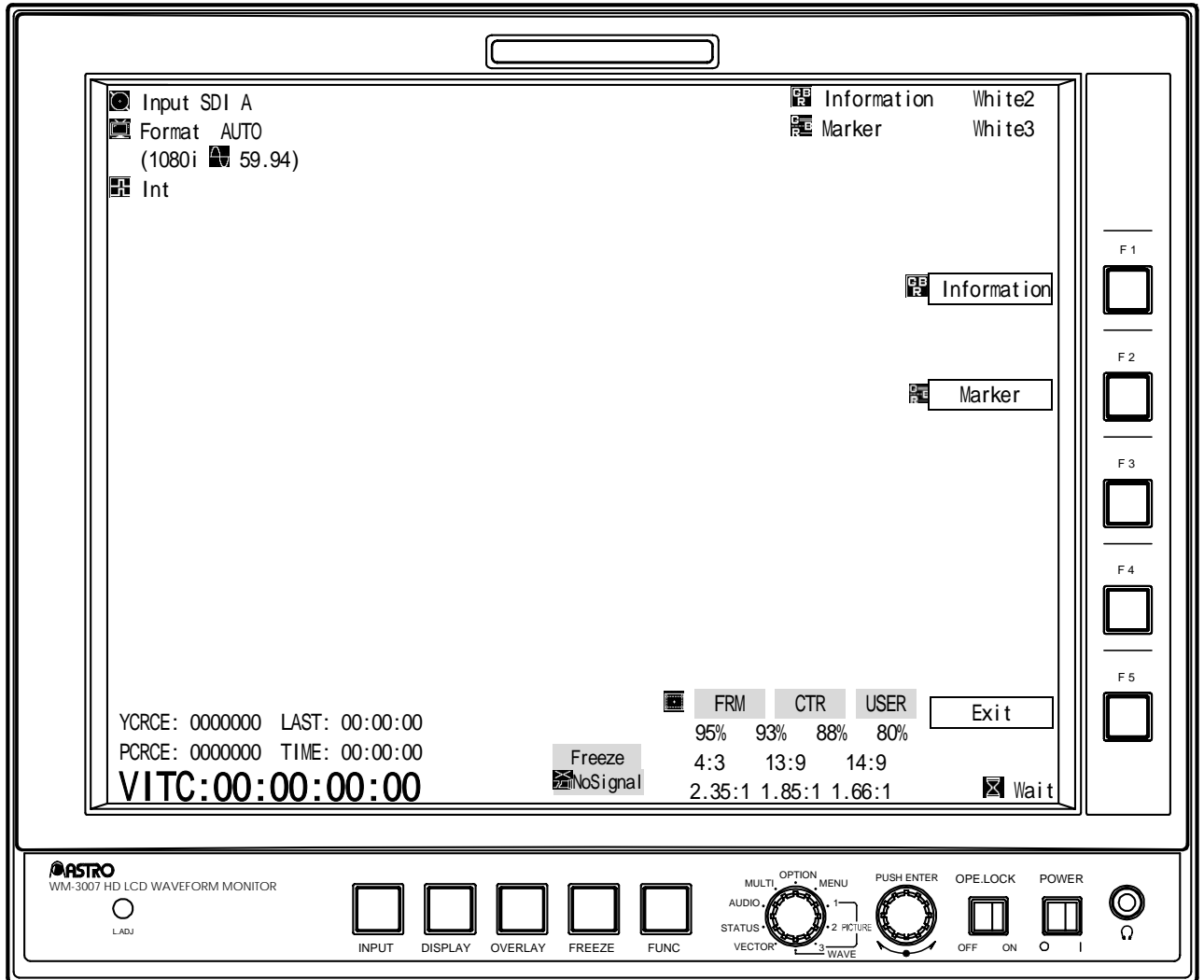
#### <<Color setting screen>>



**[Description of operations]**

Switch	Description of function
FUNC switch	Use this to return the display to the regular screen. (Refer to Section 3.4.2.1.)
F1 switch  Information	Use this to select the color of the text (from 63 colors) by turning the adjustment dial. When the adjustment dial is pressed, the text color is restored to the initial value.
F2 switch  Marker	Use this to select the color of the text (from 64 colors) by turning the adjustment dial. When the adjustment dial is pressed, the text color is restored to the initial value.
F3 switch	(Not used)
F4 switch	(Not used)
F5 switch  Exit	Use this to return the display to the regular screen. (Refer to Section 3.4.2.1.)
OVERLAY switch	When this is held down, the display is returned to the regular screen. (Refer to Section 3.4.2.1.)

**3.4.3 PICTURE3 mode**

When the LOCK switch is set to ON and both the FUNC switch and one of the F1 to F5 switches are pressed together, the current settings are saved in the F switch (F1 to F5) concerned.

 Wait appears at the bottom right of the screen while the settings are being saved.

Do not turn off the power during this process. If the power is turned off while the settings are being saved, the initial settings may be saved instead of the settings to be saved.

To load the saved settings, establish the option mode, and press the F switch (F1 to F5) in which the settings were saved.

### 3.4.3.1 Regular screen

#### <<Functions>>



The input images can be displayed so that the following settings can be performed.

- H Delay
- V Delay
- MAG

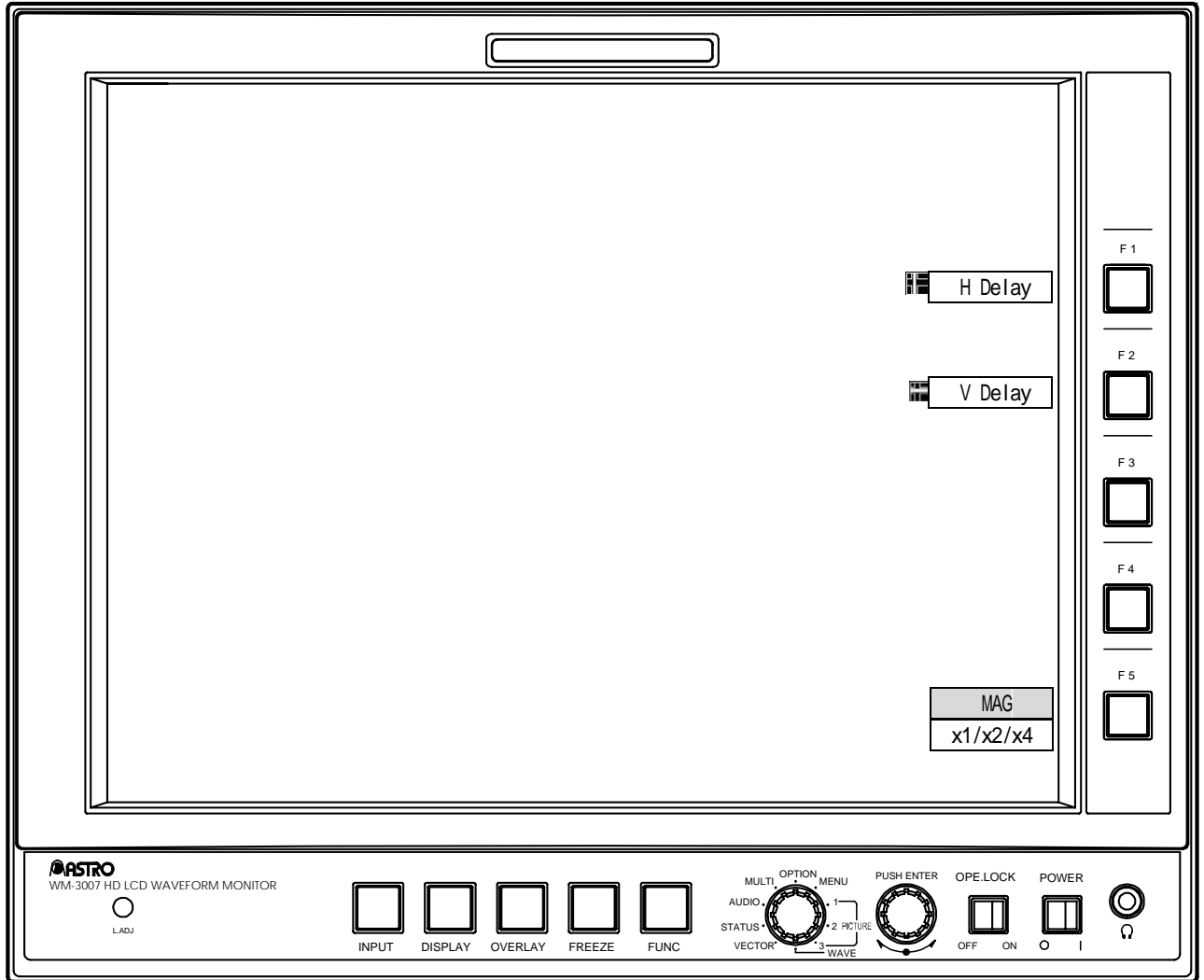
#### <<Screen>>



**[Description of operations]**

Switch	Description of function
FUNC switch	(Not used)
F1 switch  H Delay	Use this to select ON or OFF for H Delay. Even while H Delay is set to ON using this switch, once the PICTURE3 mode is exited, H Delay will return to OFF. The FREEZE switch does not work while H Delay is ON. Switching from ON to OFF or vice versa is not possible in the freeze status.
F2 switch  V Delay	Use this to select ON or OFF for V Delay. Even while V Delay is set to ON using this switch, once the PICTURE3 mode is exited, V Delay will return to OFF. The FREEZE switch does not work while V Delay is ON. Switching from ON to OFF or vice versa is not possible in the freeze status.
F3 switch	(Not used)
F4 switch	(Not used)
F5 switch  MAG x1/x2/x4	Use this to select the MAG magnification rate (x1, x2 or x4). Even while MAG is set to x2 or x4 using this switch, once the PICTURE3 mode is exited MAG will return to x1. The FREEZE switch does not work while MAG is set to x2 or x4. MAG cannot be switched in the freeze status. Information is not displayed at the x2 or x4 MAG setting.

### 3.4.3.2 Color setting screen

#### <<Functions>>

By holding down the OVERLAY switch in the PICTURE3 mode, the input images can be displayed so that the following settings can be performed.

- Text color
- Marker color

#### <<Color setting screen>>

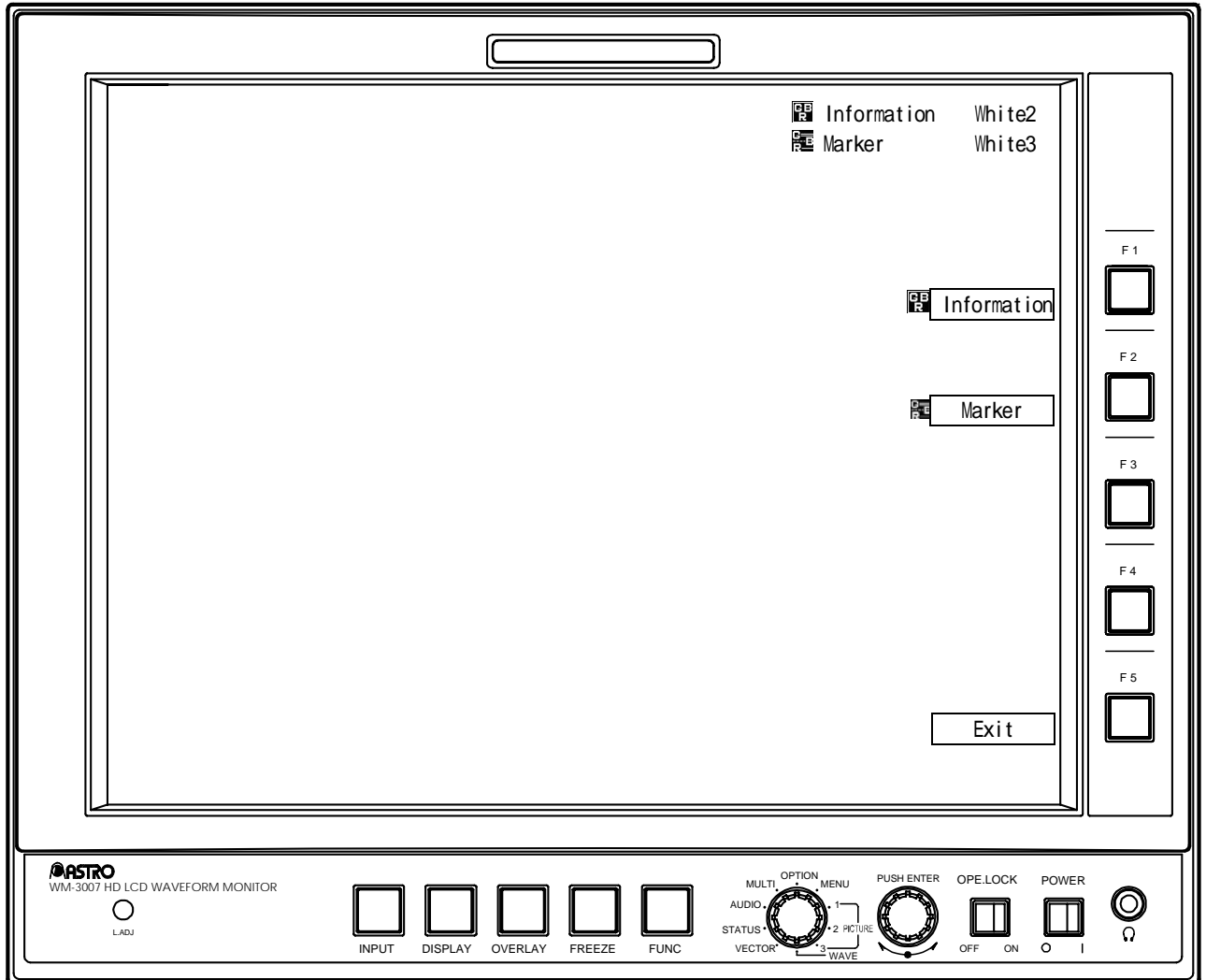

#### [Description of operations]

Switch	Description of function
FUNC switch	Use this to return the display to the regular screen. (Refer to section 3.4.3.1)
F1 switch Information	Press this to select the color (any of 63 colors) of the characters using the adjustment dial. When the setting switch is pressed, the character color is restored to the initial value.
F2 switch Marker	Press this to select the color (any of 64 colors) of the characters using the adjustment dial. When the setting switch is pressed, the character color is restored to the initial value.
F3 switch	(Not used)
F4 switch	(Not used)
F5 switch Exit	Use this to return the display to the regular screen. (Refer to section 3.4.3.1)
OVERLAY switch	When this is held down, the display is returned to the regular screen. (Refer to section 3.4.3.1)

### 3.4.4 WAVEFORM mode

When the LOCK switch is set to ON and both the FUNC switch and one of the F1 to F5 switches are pressed together, the current settings are saved in the F switch (F1 to F5) concerned.

 Wait appears at the bottom right of the screen while the settings are being saved.

Do not turn off the power during this process. If the power is turned off while the settings are being saved, the initial settings may be saved instead of the settings to be saved.

To load the saved settings, establish the option mode, and press the F switch (F1 to F5) in which the settings were saved.

### 3.4.4.1 Function screen

#### <<Functions>>

The waveforms are displayed on this screen.

#### <<Screen>>

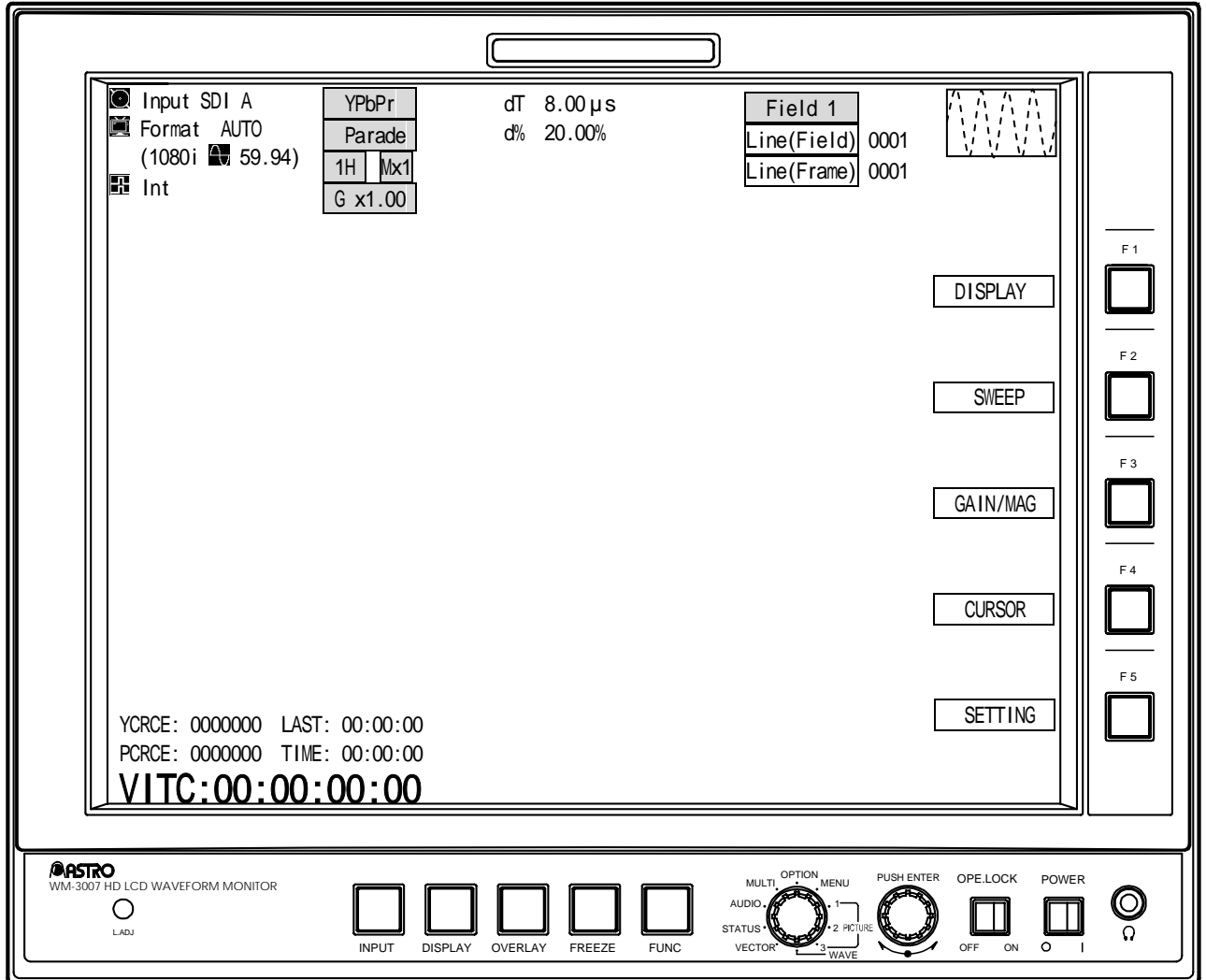

#### [Description of operations]

Switch	Description of function
FUNC switch	Use this to return the display to the previous screen.
Adjustment dial	(Not used)
F1 switch DISPLAY	Press this to set the display to the DISPLAY setting screen. (Refer to section 3.4.4.2)
F2 switch SWEEP	Press this to set the display to the SWEEP setting screen. (Refer to section 3.4.4.3)
F3 switch GAIN/MAG	Press this to set the display to the GAIN/MA setting screen. (Refer to section 3.4.4.4)
F4 switch CURSOR	Press this to set the display to the CURSOR setting screen. (Refer to section 3.4.4.5)
F5 switch SETTING	Press this to set the display to the WAVEFORM mode setting screen. (Refer to section 3.4.4.6)

### 3.4.4.2 DISPLAY setting screen

#### <<Functions>>

The waveforms can be displayed, and the following settings can be performed.

- Switching between parade display (side-by-side display) and overlay display (superimposed display) for the waveforms
- Line select function (with 1H, 2H)

#### <<Screen>>

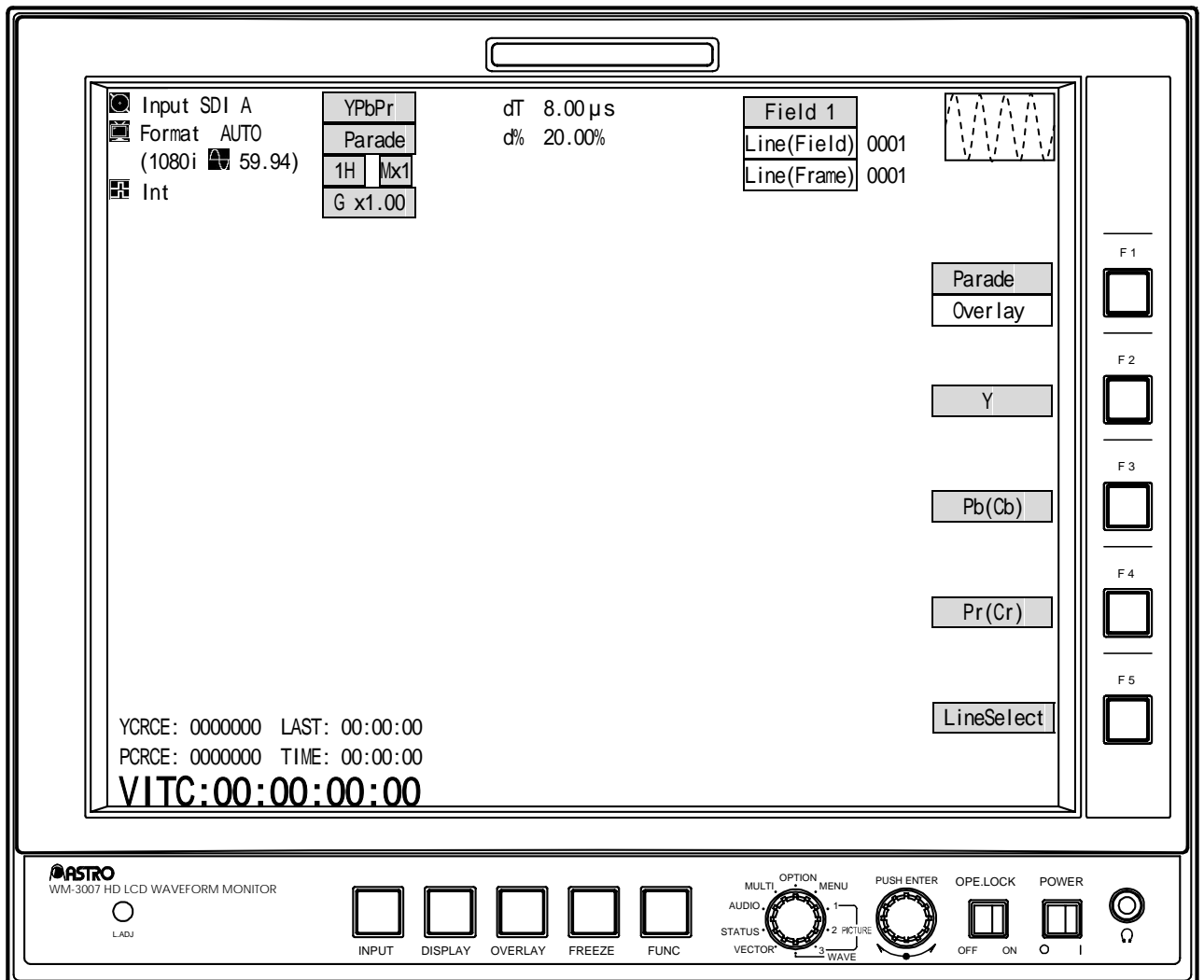

**[Description of operations]**

Switch	Description of function
FUNC switch	Press this to return the display to the function screen. (Refer to section 3.4.4.1)
F1 switch Parade/Overlay	Press this to switch between parade display (side-by-side display) and overlay display (superimposed display) for the waveforms.
F2 switch Y	Press this to set Y/G to ON or OFF.
F3 switch Pb(Cb)	Press this to set Pb/B to ON or OFF.
F4 switch Pr(Cr)	Press this to set Pr/R to ON or OFF.
F5 switch LineSelect	Use this to set line select to ON or OFF. When line select is ON, the lines are incremented or decremented by turning the adjustment dial, and the field is switched by pressing the adjustment dial. The line select ON/OFF and line settings are interlinked in the WAVEFORM mode, VECTOR mode and STATUS mode. (This applies with 1H or 2H only; field switching applies only with the interlacing or segmented frame format.)

### 3.4.4.3 SWEEP setting screen

#### <<Functions>>

The waveforms can be displayed, and the following settings can be performed.

- 1H, 2H, 1F or 2F display switching
- Line select function (with 1H or 2H)

#### <<Screen>>

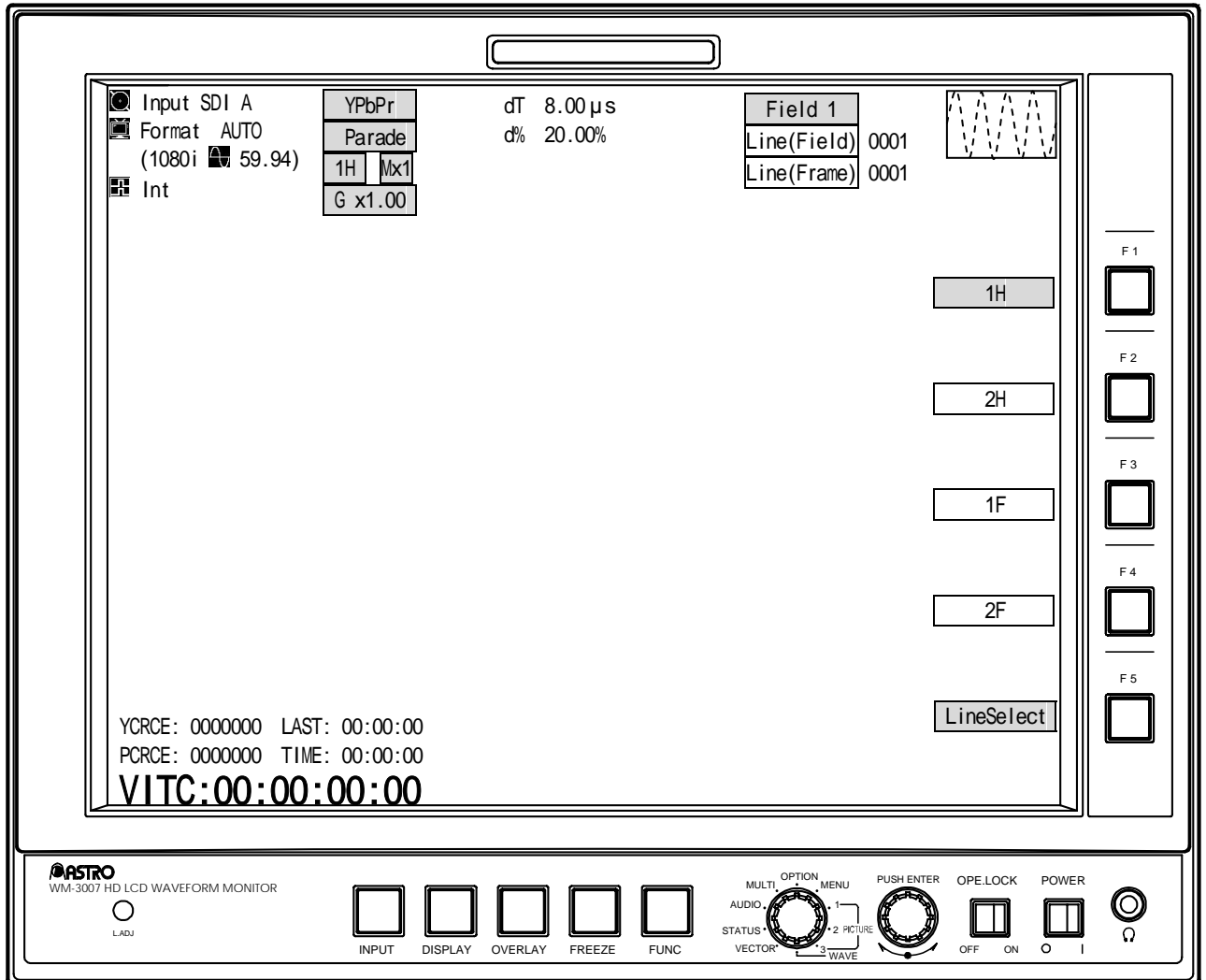

**[Description of operations]**

Switch	Description of function
FUNC switch	Press this to return the display to the function screen. (Refer to section 3.4.4.1)
F1 switch 1H	Use this to set the 1H display.
F2 switch 2H	Use this to set the 2H display (with the interlacing or segmented frame format). In the line select OFF status, the odd-numbered fields are displayed on the left side, and the even-numbered fields are displayed on the right side. In the line select ON status, the selected line is displayed on the left side, and the next line in the selected field is displayed on the right side.
F3 switch 1F	Use this to set the 1F display. The horizontal blanking data is not displayed.
F4 switch 2F	Use this to set the 2F display (with the interlacing or segmented frame format). The odd-numbered fields are displayed on the left side, and the even-numbered fields are displayed on the right side. The horizontal blanking data is not displayed.
F5 switch LineSelect	Use this to set line selection to ON or OFF. In the line select ON status, the lines are incremented or decremented by turning the adjustment dial, and the field is switched by pressing the adjustment dial. The line select ON/OFF and line settings are interlinked in the WAVEFORM mode, VECTOR mode and STATUS mode. (This applies with 1H or 2H only; field switching applies only with the interlacing or segmented frame format.)

### 3.4.4.4 GAIN/MAG setting screen

<<Functions>>

The waveforms can be displayed, and the following settings can be performed.。

- Gain (0.03X to 7.97X), MAG (1X, 2X or 4X) setting
- Scroll functions

<<Screen>>

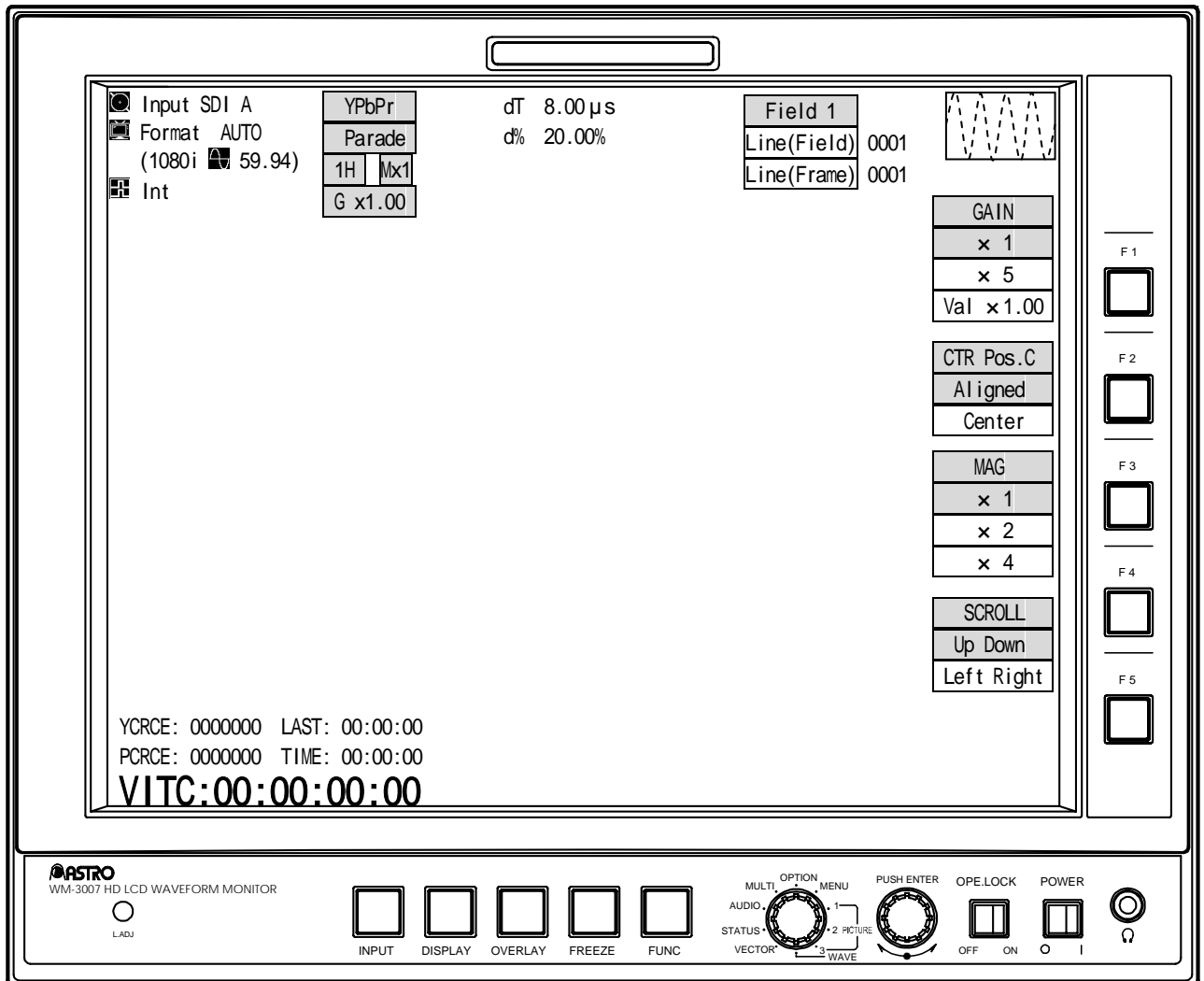

**[Description of operations]**

Switch	Description of function	
FUNC switch	Press this to return the display to the function screen. (Refer to section 3.4.4.1)	
Turning the adjustment dial	When setting the gain <input type="text" value="GainVal"/>	Use the dial to set the magnification rate of the gain. (Variable range: 0.03 to 7.97)
	When scrolling Scroll	Use the dial to scroll vertically or horizontally.
Pressing the adjustment dial	When setting the gain <input type="text" value="GainVal"/>	The gain is an integral value after the decimal places have been rounded down (with a figure of 4 or below) or rounded up (with a figure of 5 or above). (All values below 1.00 are set to 1.00; similarly, all values above 7.00 are set to 7.00.) If the gain magnification rate is an integer, it is increased in 1.00 increments, and when 7.00 is reached, it is returned to 1.00.)
	When setting the gain <input type="text" value="GainVal"/>	Use the dial to set the magnification rate of the gain. (Variable range: 0.03 to 7.97)
F1 switch <input type="text" value="GAIN x1"/> / <input type="text" value="GAIN x5"/> / <input type="text" value="GAIN Val x*.**"/>	Use this to select the GAIN magnification rate (x1 or x5) or switch the adjustment dial function to the gain setting (Val x*.**).	
F2 switch <input type="text" value="CTR Pos.C Aligned"/> / <input type="text" value="CTR Pos.C Center"/>	Use this to select the position where the Pb (Cb) and Pr (Cr) signals are to be displayed during GAIN magnification. The switch is fixed at <input type="text" value="Aligned"/> when the GBR signals are selected with the waveform display. (Refer to Section 3.4.4.6.)	
F3 switch <input type="text" value="MAG x1"/> / <input type="text" value="MAG x2"/> / <input type="text" value="MAG x4"/>	Use this to set the MAG magnification rate (x1, x2 or x4).	
F4 switch <input type="text" value="Scroll Up Down"/> / <input type="text" value="Scroll Left Right"/>	Use this to select vertical (up/down) or horizontal (left/right) scrolling. If H Blank is not ON when 1H or 2H has been selected or if V Anc (Wave) is not ON when 1F or 2F has been selected, the blanking data will not be displayed even when the display is scrolled horizontally. (For details on 1H, 2H, 1F and 2F, refer to Section 3.4.4.3.)	
F5 switch	(Not used)	

### 3.4.4.5 CURSOR setting screen

#### <<Functions>>





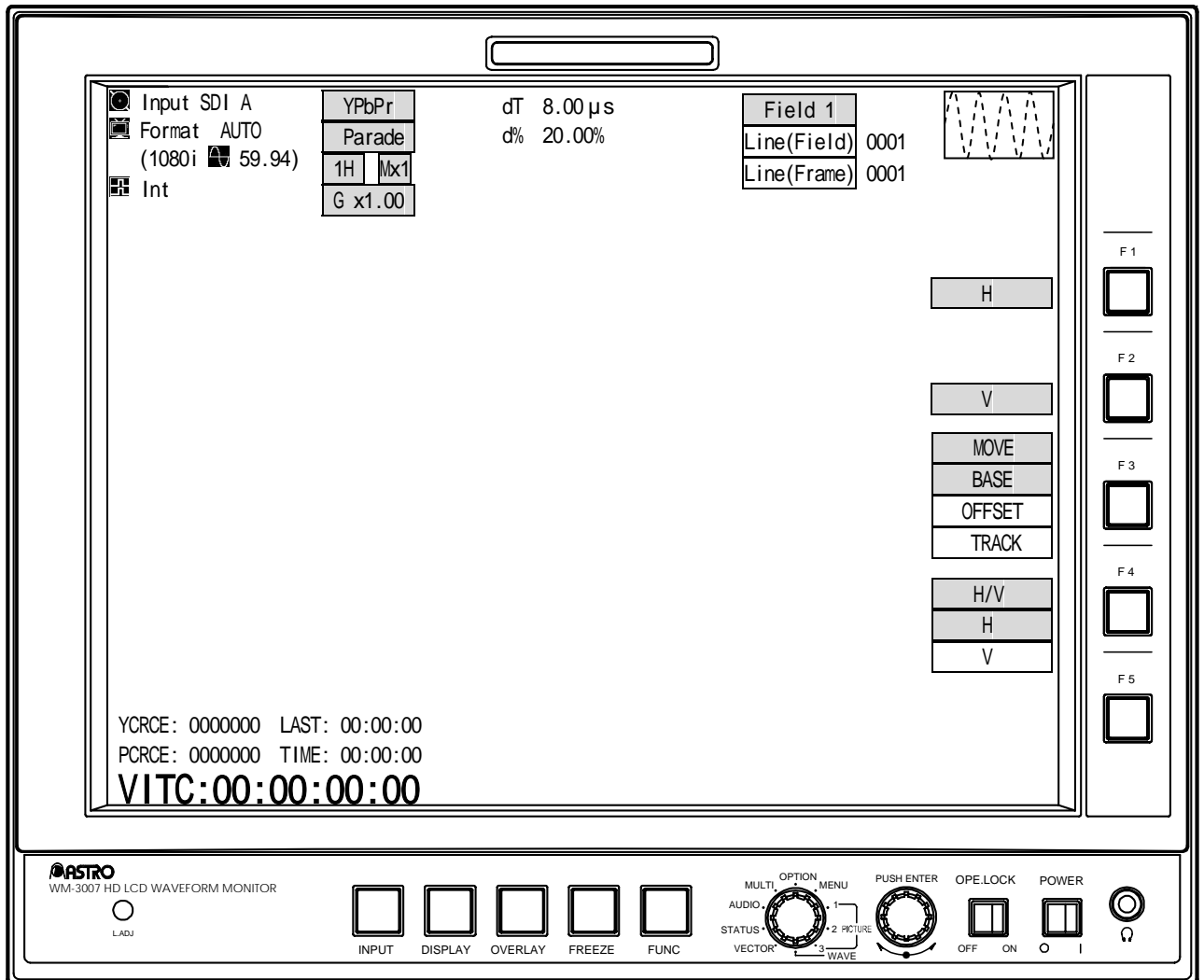

The waveforms can be displayed, and the following settings can be performed.

- H and V cursor display and difference display (mV,  $\mu$ s)

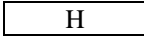
#### <<Screen>>

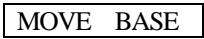

**[Description of operations]**

Switch	Description of function
FUNC switch	Press this to return the display to the function screen. (Refer to section 3.3.4.1)
Adjustment dial	Press this to set the H cursor to ON or OFF.
F1 switch 	Press this to set the H cursor to ON or OFF.
F2 switch 	Press this to set the V cursor to ON or OFF.
F3 switch  /  / 	Press this to select the cursor (BASE, OFFSET or TRACK) to be moved.
F4 switch  / 	Press this to select the cursor (H or V) to be moved.
F5 switch	(Not used)

### 3.4.4.6 WAVEFORM mode setting screen

#### <<Functions>>

The waveforms can be displayed, and the following settings can be performed.。

- Waveform display YPbPr/GBR switching
- V ancillary (Wave), H blanking switching
- Scale switching
- Filter selection

#### <<Screen>>

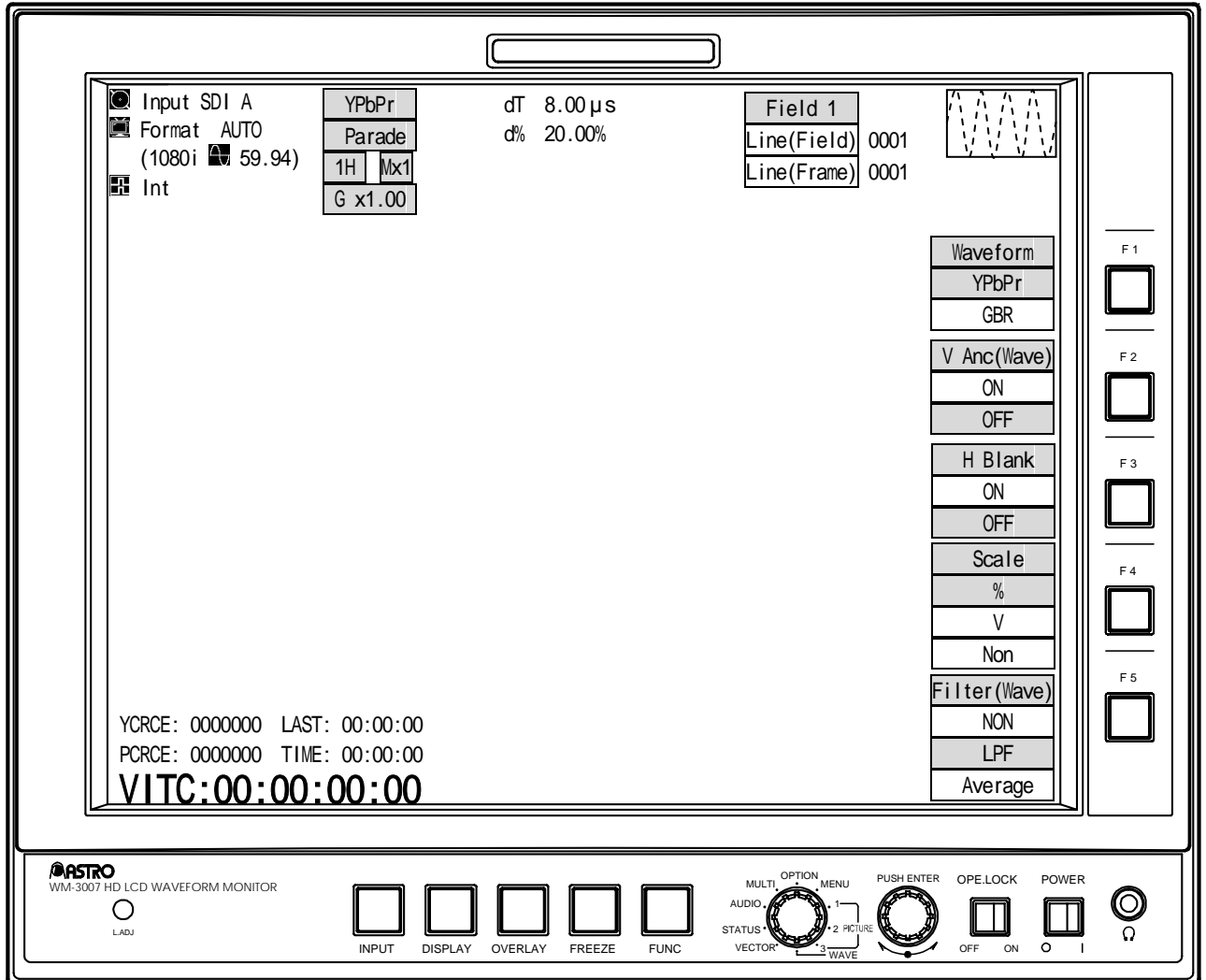

**[Description of operations]**

Switch	Description of function
FUNC switch	Press this to return the display to the function screen. (Refer to section 3.4.4.1)
Adjustment dial	(Not used)
F1 switch <div style="border: 1px solid black; padding: 2px; display: inline-block;">Waveform YPbPr</div> / <div style="border: 1px solid black; padding: 2px; display: inline-block;">Waveform GBR</div>	Press this to switch between YPbPr and GBR for the waveform display.
F2 switch <div style="border: 1px solid black; padding: 2px; display: inline-block;">V Anc ON</div> / <div style="border: 1px solid black; padding: 2px; display: inline-block;">V Anc OFF</div>	Press this to set V ancillary to ON or OFF. This takes effect only when the WAVEFORM mode is established.
F3 switch <div style="border: 1px solid black; padding: 2px; display: inline-block;">H Blank ON</div> / <div style="border: 1px solid black; padding: 2px; display: inline-block;">H Blank OFF</div>	Press this to set H blanking to ON or OFF. To view the H blanking waveforms, set to ON, and set the scroll to horizontal. (For details on horizontal scrolling, refer to Section 3.4.4.4.)
F4 switch <div style="border: 1px solid black; padding: 2px; display: inline-block;">Scale %</div> / <div style="border: 1px solid black; padding: 2px; display: inline-block;">Scale V</div> / <div style="border: 1px solid black; padding: 2px; display: inline-block;">Scale Non</div>	Press this to switch the scale units between % and V.
F5 switch <div style="border: 1px solid black; padding: 2px; display: inline-block;">Filter (Wave) NON</div> / <div style="border: 1px solid black; padding: 2px; display: inline-block;">Filter (Wave) LPF</div> / <div style="border: 1px solid black; padding: 2px; display: inline-block;">Filter (Wave) Average</div>	Use this to set the filter (Wave) to ON or OFF and the type of filter. It takes effect only when the WAVEFORM mode is established. LPF frequency characteristics Y: 6 MHz (-3 dB), PbPr: 3 MHz (-3 dB) The data of the previous and next 8 pixels is averaged out for "Average."

### 3.4.4.7 Color setting screen

#### <<Functions>>



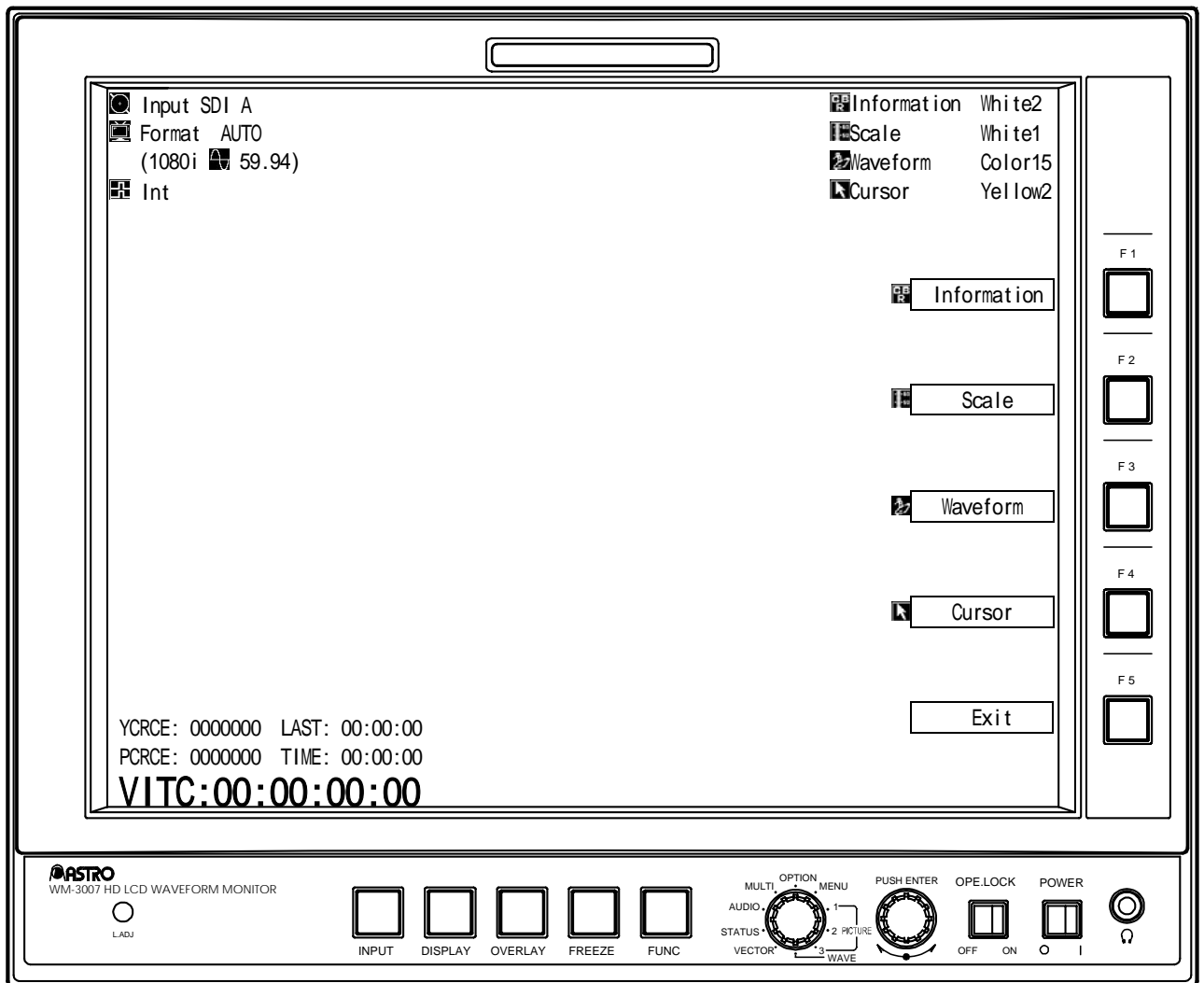

When the OVERLAY switch is held down in the WAVEFORM mode, the following settings can be performed.

- Character color
- Scale color
- Waveform color and brightness
- Cursor color

#### <<Screen>>

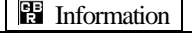

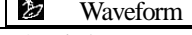
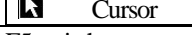
**[Description of operations]**

Switch	Description of function
FUNC switch	Use this to return the display to the previous screen.
F1 switch 	Press this to select the color (any of 63 colors) of the characters using the adjustment dial. When the setting switch is pressed, the character color is restored to the initial value.
F2 switch 	Press this to select the color (any of 63 colors) of the scale using the adjustment dial. When the setting switch is pressed, the scale color is restored to the initial value.
F3 switch 	Press this to select the color (any of 62 colors) and brightness of the waveforms using the adjustment dial. When the setting switch is pressed, the waveform color is restored to the initial value.
F4 switch 	Press this to select the color (any of 63 colors) of the cursor using the adjustment dial. When the setting switch is pressed, the cursor color is restored to the initial value.
F5 switch 	Press this to return the display to the previous screen.
OVERLAY switch	When this is held down, the display is returned to the previous screen.

### 3.4.5 VECTOR mode

When the LOCK switch is set to ON and both the FUNC switch and one of the F1 to F5 switches are pressed together, the current settings are saved in the F switch (F1 to F5) concerned.

 Wait appears at the bottom right of the screen while the settings are being saved.

Do not turn off the power during this process. If the power is turned off while the settings are being saved, the initial settings may be saved instead of the settings to be saved.

To load the saved settings, establish the option mode, and press the F switch (F1 to F5) in which the settings were saved.

### 3.4.5.1 Regular screen

#### <<Functions>>

The signals on the vectorscope can be displayed, and the following settings can be performed.

- Increase of black, white levels
- Line selection function

#### <<Screen>>

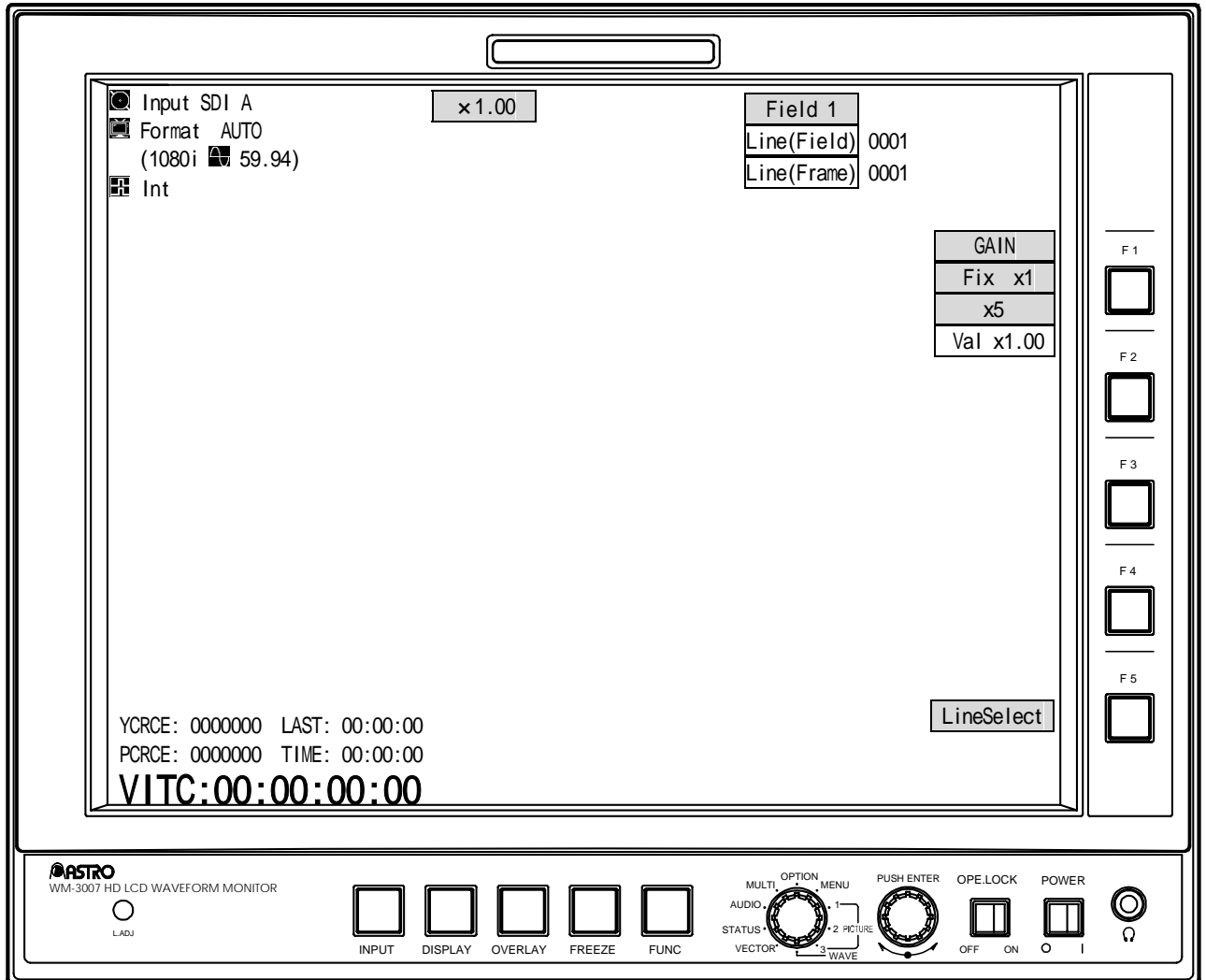

**[Description of operations]**

Switch	Description of function	
FUNC switch	This switches the display to the VECTOR mode setting screen. (Refer to section 3.4.5.2)	
Turning the adjustment dial	When the gain setting is fixed Fix x1/x5	(Not used)
	When the gain setting can be varied Val x*.**	Use the dial to set the magnification rate of the gain. (Variable range: 0.03 to 7.97)
	When line select is ON	Use the dial to increment or decrement the lines. The line select ON/OFF and line settings are interlinked in the WAVEFORM mode, VECTOR mode and STATUS mode.
Pressing the adjustment dial	When the gain setting is fixed Fix x1/x5	(Not used)
	When the gain setting can be varied Val x*.**	The gain is an integral value after the decimal places have been rounded down (with a figure or 4 or below) or rounded up (with a figure of 5 or above). (All values below 1.00 are set to 1.00; similarly, all values above 7.00 are set to 7.00.) If the gain magnification rate is an integer, it is increased in 1.00 increments, and when 7.00 is reached, it is returned to 1.00.)
	When line select is ON	Use the switch to select the field. (This applies with 1H or 2H only; field switching applies only with interlacing or segmented frame format.)
F1 switch GAIN Fix x1 / GAIN x5 / GAIN Val x*.**	Press this switch to set line select to OFF and switch between the fixed (Fix x1/x5) and variable (x*.**) gain setting. In the fixed (Fix x1) status, the loci between the pixels are interpolated for the display; in the variable status, only the points are displayed.	
F2 switch	(Not used)	
F3 switch	(Not used)	
F4 switch	(Not used)	
F5 switch LineSelect	Press this to set line select to ON or OFF. When line select is ON, the gain setting is fixed (Fix x1).	

### 3.4.5.2 VECTOR mode setting screen

#### <<Functions>>

The signals on the vectorscope can be displayed, and the following settings can be performed.

- V ancillary (Vect) switching
- Scale switching
- LPF (Vect) switching

#### <<Screen>>

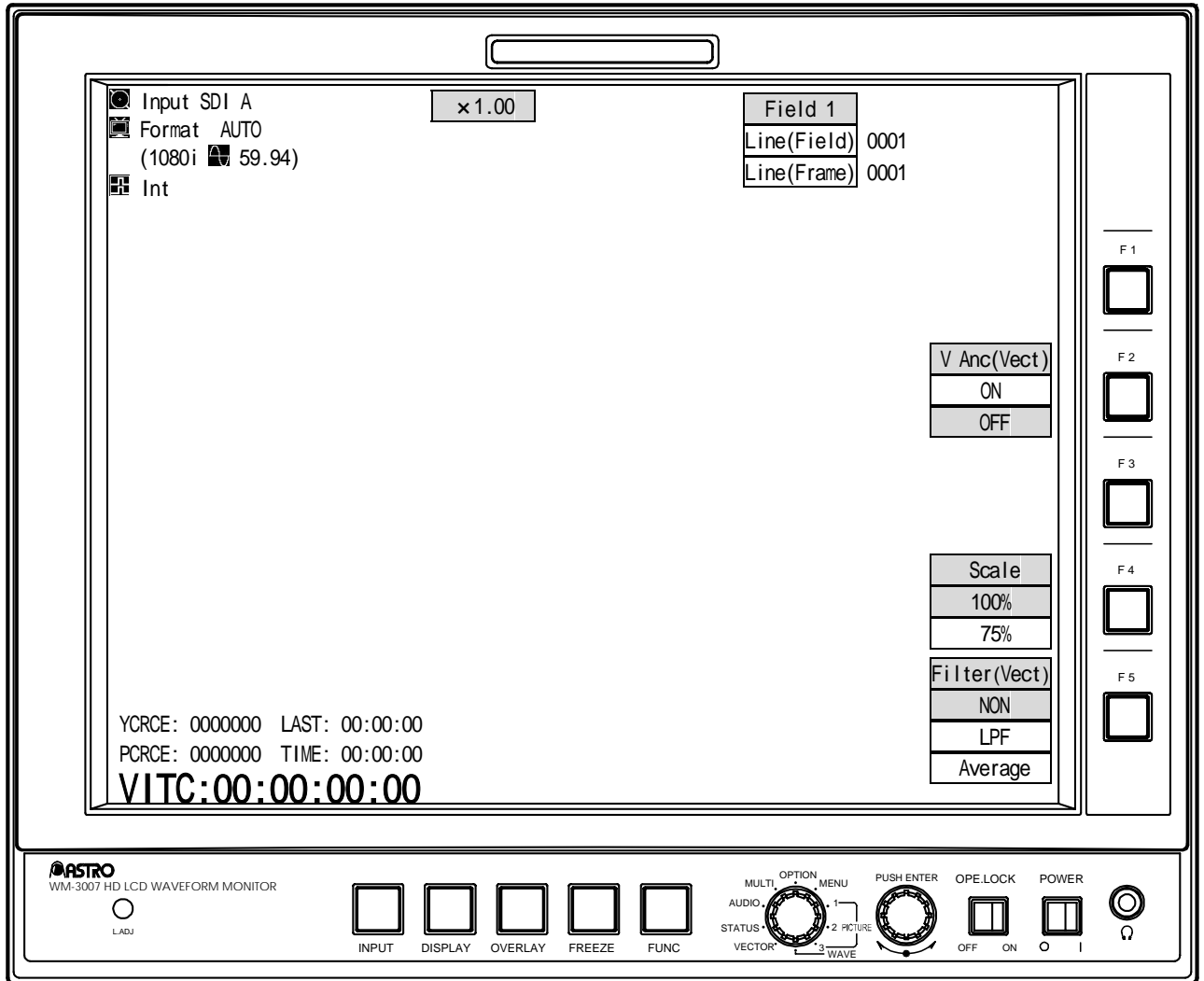

**[Description of operations]**

Switch	Description of function
FUNC switch	This switches the display to the regular screen. (Refer to section 3.4.5.1)
Adjustment dial	(Not used)
F1 switch	(Not used)
F2 switch <input type="checkbox"/> V Anc (Vect) ON / <input type="checkbox"/> V Anc (Vect) OFF	Press this to set V ancillary to ON or OFF. This takes effect only when the VECTOR mode is established.
F3 switch	(Not used)
F4 switch <input type="checkbox"/> Scale 100% / <input type="checkbox"/> Scale 75%	Press this to switch the scale between 100% or 75%.
F5 switch <input type="checkbox"/> Filter(Vect) NON / <input type="checkbox"/> Filter(Vect) LPF / <input type="checkbox"/> Filter(Vect) Average	Use this to set the filter (Wave) to ON or OFF and the type of filter. It takes effect only when the VECTOR mode is established. LPF frequency characteristics Y: 6 MHz (-3 dB), PbPr: 3 MHz (-3 dB) The data of the previous and next 8 pixels is averaged out for "Average."

### 3.4.5.3 Color setting screen

#### <<Functions>>



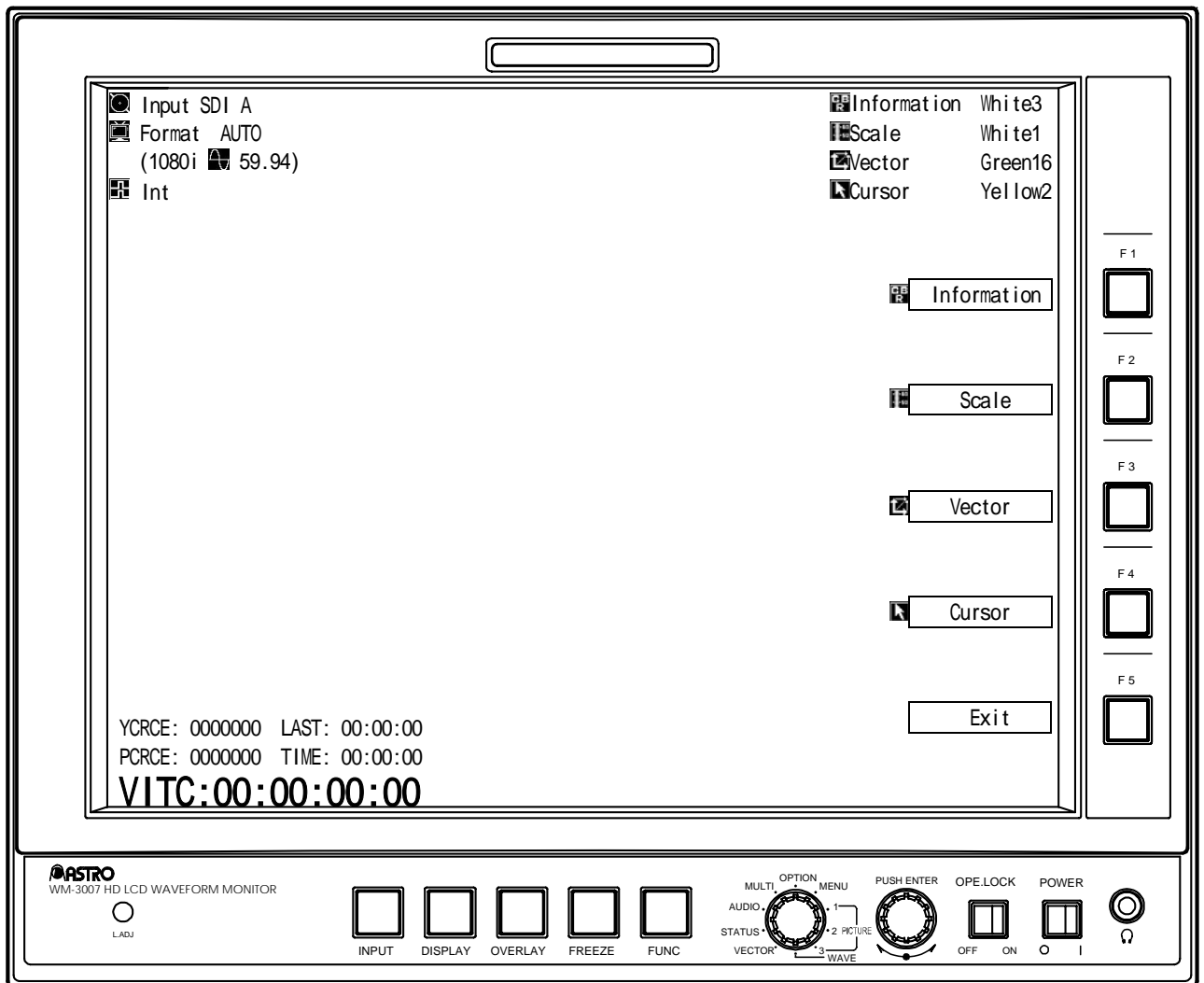

When the OVERLAY switch is held down in the VECTOR mode, the following settings can be performed.

- Character color
- Scale color
- Vector color and brightness
- Cursor color

#### <<Screen>>



**[Description of operations]**

Switch	Description of function
FUNC switch	Use this to return the display to the previous screen.
F1 switch  Information	Press this to select the color (any of 63 colors) of the characters using the adjustment dial. When the setting switch is pressed, the character color is restored to the initial value.
F2 switch  Scale	Press this to select the color (any of 63 colors) of the scale using the adjustment dial. When the setting switch is pressed, the scale color is restored to the initial value.
F3 switch  Vector	Press this to select the color (any of 160 colors) and brightness of the vectors using the adjustment dial. When the setting switch is pressed, the vector color is restored to the initial value.
F4 switch  Cursor	Press this to select the color (any of 63 colors) of the cursor using the adjustment dial. When the setting switch is pressed, the cursor color is restored to the initial value.
F5 switch Exit	Press this to return the display to the previous screen.
OVERLAY switch	When this is held down, the display is returned to the previous screen.

**3.4.6 STATUS mode**

When the LOCK switch is set to ON and both the FUNC switch and one of the F1 to F5 switches are pressed together, the current settings are saved in the F switch (F1 to F5) concerned.

 Wait appears at the bottom right of the screen while the settings are being saved.

Do not turn off the power during this process. If the power is turned off while the settings are being saved, the initial settings may be saved instead of the settings to be saved.

To load the saved settings, establish the option mode, and press the F switch (F1 to F5) in which the settings were saved.

### 3.4.6.1 Regular screen

#### <<Functions>>

The statuses can be displayed, and the following settings can be performed.

- Status (numerical value) display
- EAV, SAV display

#### <<Screen>>

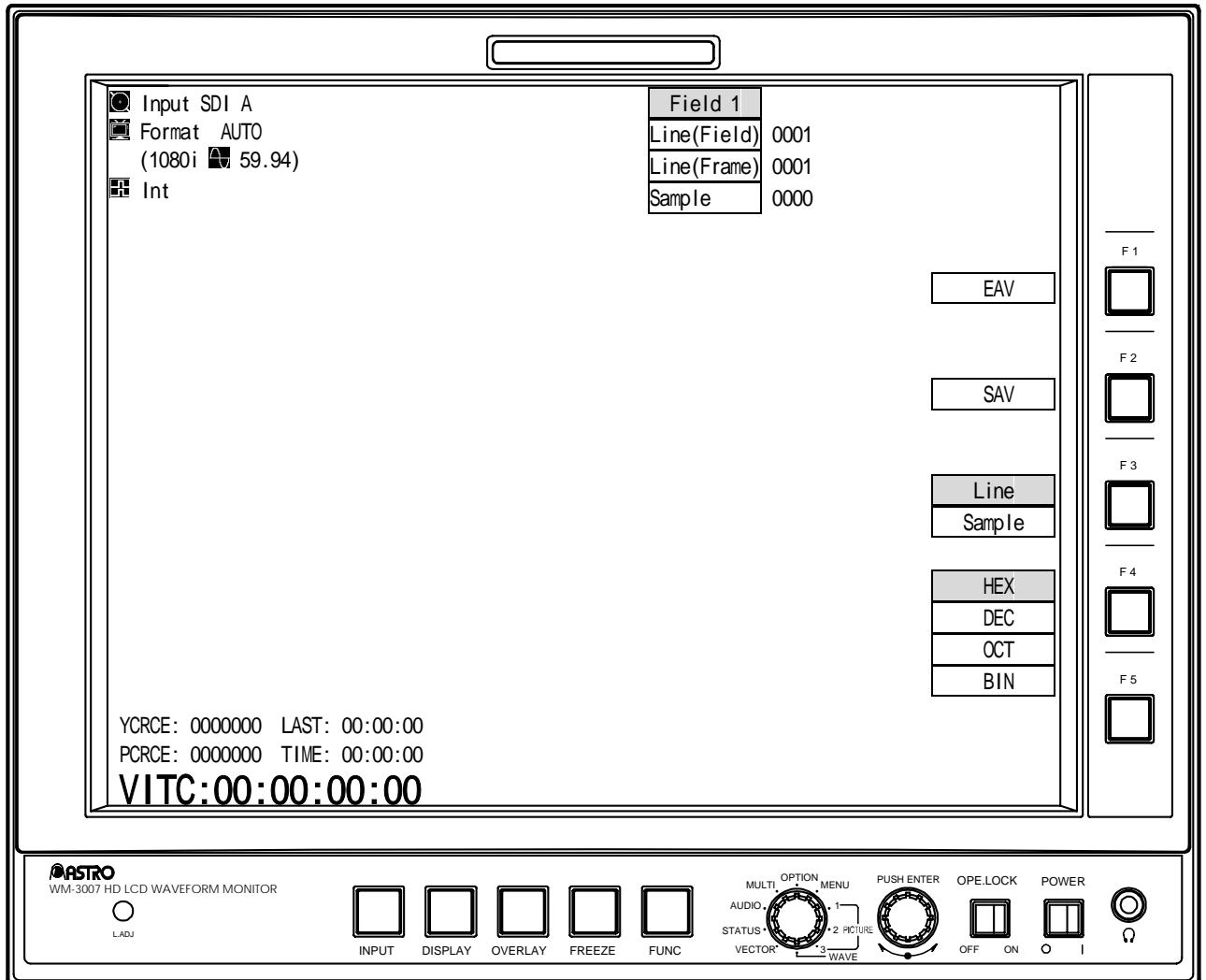

**[Description of operations]**

Switch	Description of function
FUNC switch	(Not used)
Turning the adjustment dial	Use the dial to increment or decrement the lines or samples in the status displayed. The lines are interlinked in the WAVEFORM mode, VECTOR mode and STATUS mode.
Pressing the adjustment dial	Use the dial to increment or decrement the lines or samples in the status displayed.
F1 switch EAV	Press this to select the field (with interlacing or segmented frame format).
F2 switch SAV	Press this to jump to EAV.
F3 switch Line / Sample	Press this to jump to SAV.
F4 switch HEX / DEC / OCT / BIN	Press this to select the item (Line or Sample) to be set using the adjustment dial.
F5 switch	(Not used)

### 3.4.6.2 Color setting screen

#### <<Functions>>



When the OVERLAY switch is held down in the STATUS mode, the following settings can be performed.

- Character color
- Scale color
- Status color
- Cursor color

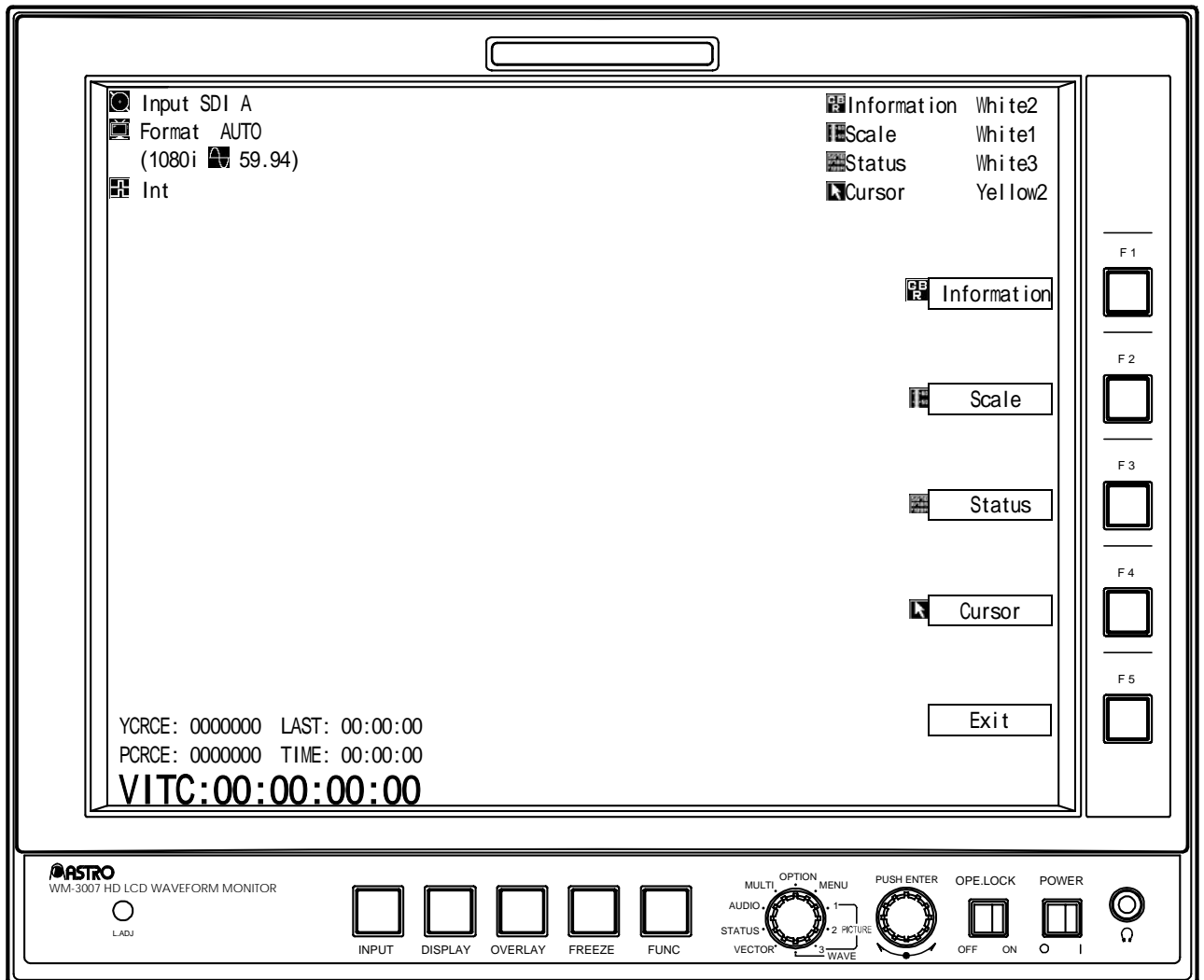
#### <<Screen>>

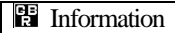
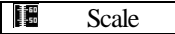

**[Description of operations]**

Switch	Description of function
FUNC switch	Use this to return the display to the regular screen. (Refer to Section 3.4.6.1.)
F1 switch  Information	Press this to select the color (any of 63 colors) of the characters using the adjustment dial. When the setting switch is pressed, the character color is restored to the initial value.
F2 switch  Scale	Press this to select the color (any of 63 colors) of the scale using the adjustment dial. When the setting switch is pressed, the scale color is restored to the initial value.
F3 switch  Status	Press this to select the color (any of 63 colors) of the statuses using the adjustment dial. When the setting switch is pressed, the status color is restored to the initial value.
F4 switch  Cursor	Press this to select the color (any of 63 colors) of the cursor using the adjustment dial. When the setting switch is pressed, the cursor color is restored to the initial value.
F5 switch Exit	Use this to return the display to the regular screen. (Refer to Section 3.4.6.1.)
OVERLAY switch	When this is held down, the display is returned to the regular screen. (Refer to Section 3.4.6.1.)

**3.4.7 AUDIO mode**

When the LOCK switch is set to ON and both the FUNC switch and one of the F1 to F5 switches are pressed together, the current settings are saved in the F switch (F1 to F5) concerned.

 Wait appears at the bottom right of the screen while the settings are being saved.

Do not turn off the power during this process. If the power is turned off while the settings are being saved, the initial settings may be saved instead of the settings to be saved.

To load the saved settings, establish the option mode, and press the F switch (F1 to F5) in which the settings were saved.

### 3.4.7.1 Audio level meter screen

#### <<Functions>>

- Display of 16 audio channel levels
- Selection of headphone output channels and volume level adjustment

#### <<Screen>>

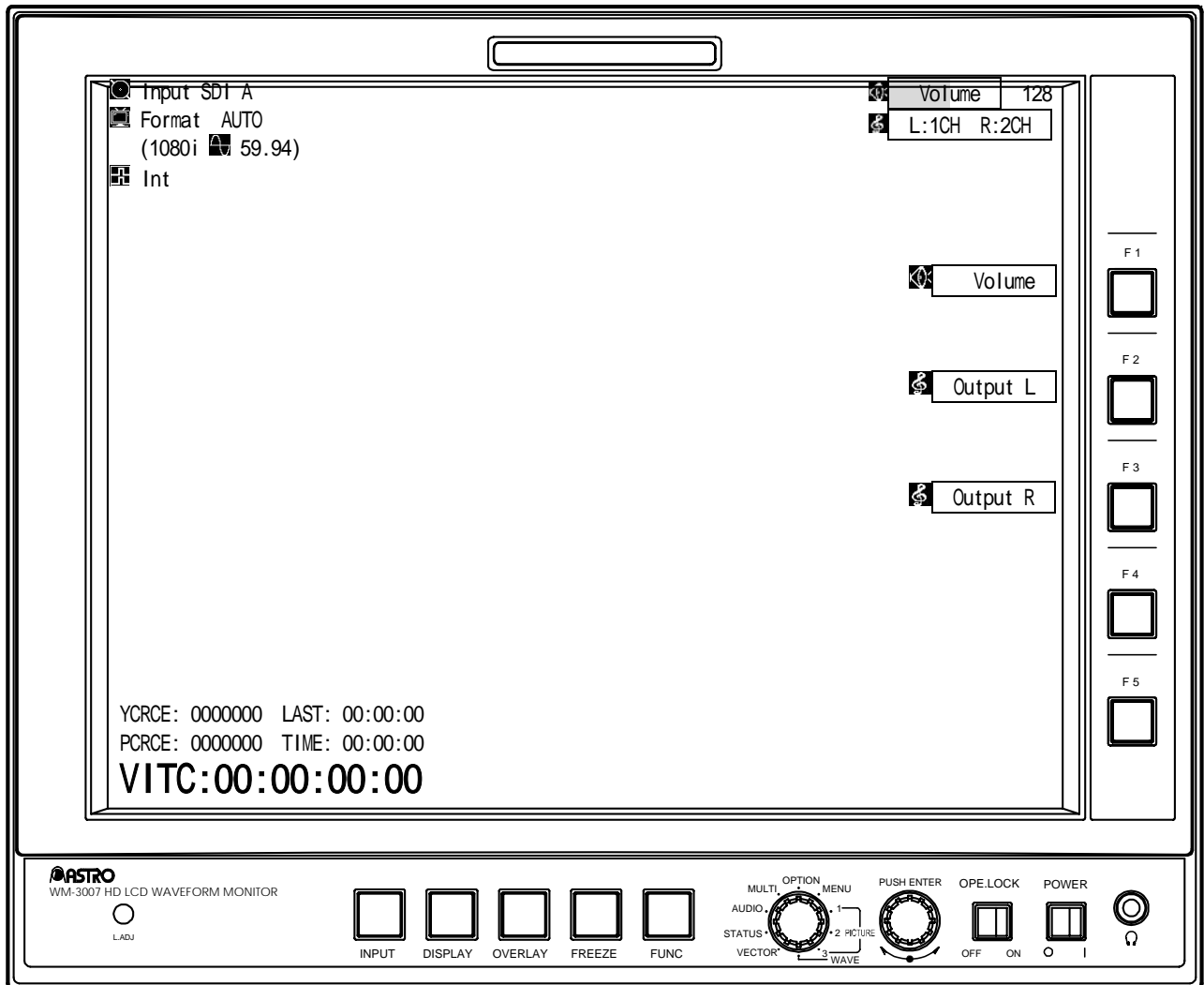

#### [Description of operations]

Switch	Description of function
FUNC switch	Use this to return the display to the audio vector screen. (Refer to Section 3.4.7.2.)
F1 switch Volume	Use this to adjust the volume level by turning the adjustment dial. Variable range: 0 to 255 When the adjustment dial is pressed, the volume level is restored to the initial value.
F2 switch Output L	Press the F2 switch, and turn the adjustment dial to set the headphone output left channel. When the adjustment dial is pressed, the output channel is restored to the initial value.
F3 switch Output R	Press the F2 switch, and turn the adjustment dial to set the headphone output right channel. When the adjustment dial is pressed, the output channel is restored to the initial value.
F4 switch	(Not used)
F5 switch	(Not used)

\* The audio level meter performs pixel skip sampling. As such, slight errors may occur in the values displayed at such levels as the high-frequency components.

### 3.4.7.2 Audio vector screen



#### <<Functions>>

- Display of left and right vectors selected for headphone output
- Selection of headphone output channels and volume level adjustment
- Setting of GAIN (x1, x2, x4, x8 or x16)

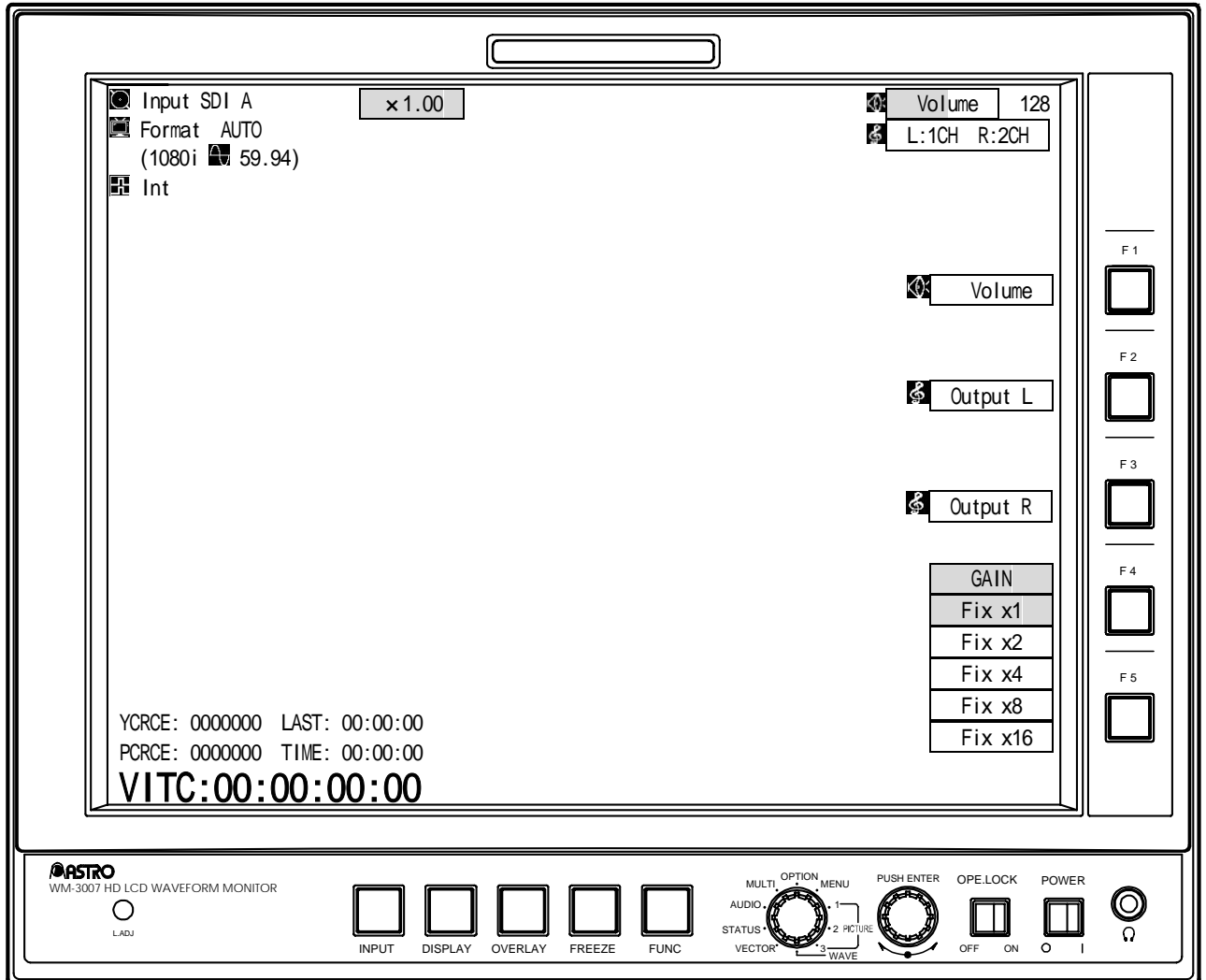
#### <<Screen>>



**[Description of operations]**

Switch	Description of function
FUNC switch	Use this to switch the display to the audio level meter screen. (Refer to Section 3.4.7.1.)
F1 switch  Volume	Use this to adjust the volume level by turning the adjustment dial. Variable range: 0 to 255 When the adjustment dial is pressed, the volume level is restored to the initial value.
F2 switch  Output L	Press the F2 switch, and turn the adjustment dial to set the headphone output left channel. When the adjustment dial is pressed, the output channel is restored to the initial values.
F3 switch  Output R	Press the F3 switch, and turn the adjustment dial to set the headphone output right channel. When the adjustment dial is pressed, the output channel is restored to the initial values.
F4 switch GAIN    Fix x1 / GAIN    Fix x2 / GAIN    Fix x4 / GAIN    Fix x8 / GAIN    Fix x16 /	Use this to change the magnification of the audio vector waveforms. Each time the F4 switch is pressed, the magnification changes by one step in the sequence of x1, x2 ... x16.
F5 switch	(Not used)



The freeze status does not function on the audio vector screen. The FREEZE switch can be used to switch between freeze and update, but bear in mind that on this screen the update status is established all the time internally.

Once it is switched to another screen or mode, the freeze/update status will function.

### 3.4.7.2 Color setting screen

#### <<Functions>>



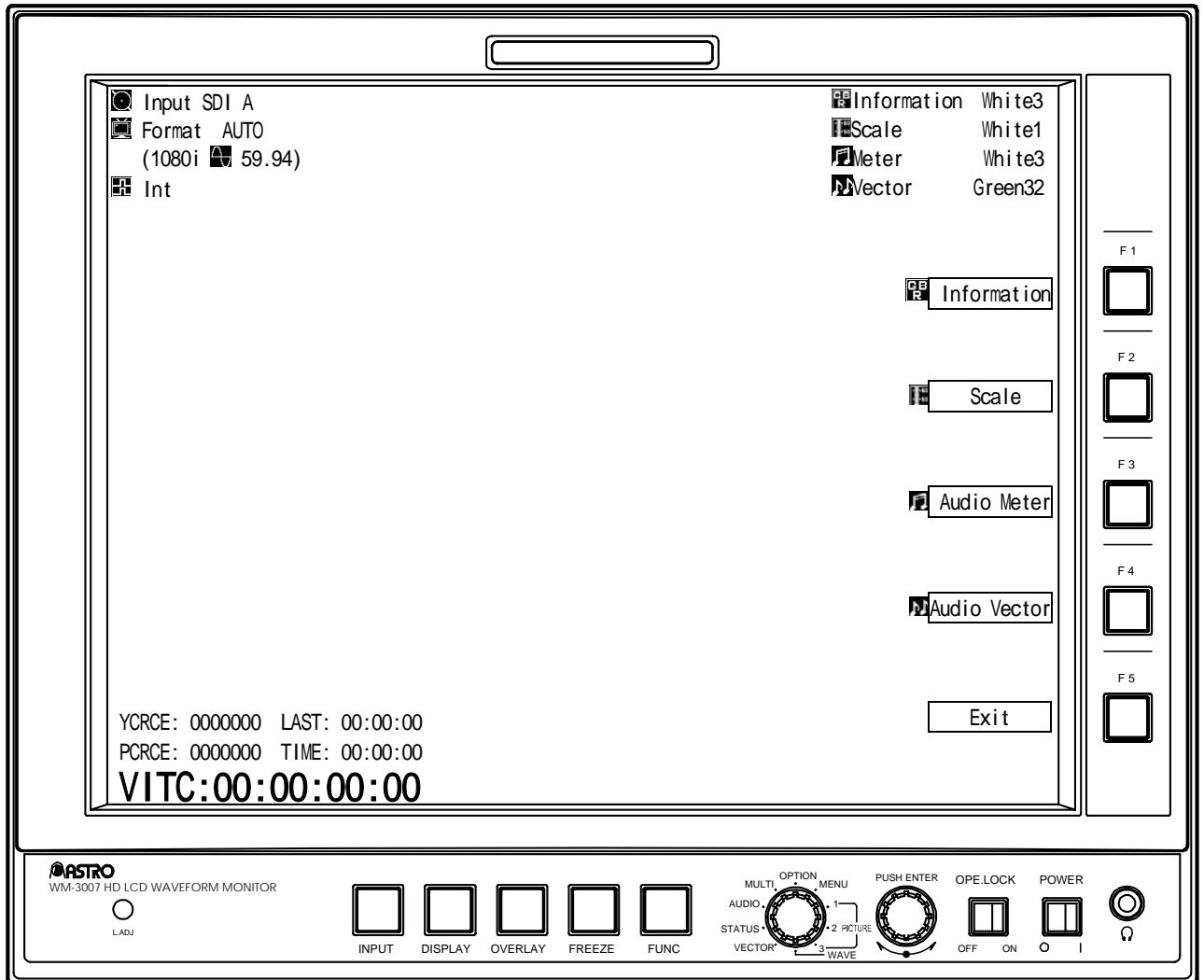

By holding down the OVERLAY switch in the AUDIO mode, the following settings can be performed.

- Text color
- Scale color
- Audio level meter color
- Audio vector waveform color

#### <<Screen>>



**[Description of operations]**

Switch	Description of function
FUNC switch	Use this to return the display to the previous screen.
F1 switch  Information	Use this to select the color of the text (from 63 colors) by turning the adjustment dial. When the adjustment dial is pressed, the text color is restored to the initial value.
F2 switch  Scale	Use this to select the color of the scale (from 63 colors) by turning the adjustment dial. When the adjustment dial is pressed, the scale color is restored to the initial value.
F3 switch  Audio Meter	Use this to select the color of the audio level meter (from 63 colors) by turning the adjustment dial. When the adjustment dial is pressed, the audio level meter color is restored to the initial value.
F4 switch  Audio Vector	Use this to select the color of the audio vectors (from 128 colors) by turning the adjustment dial. When the adjustment dial is pressed, the audio vector color is restored to the initial value.
F5 switch Exit	Use this to return the display to the previous screen.
OVERLAY switch	When this is held down, the display is returned to the previous screen..

### 3.4.8 Multi mode

When the LOCK switch is set to ON and both the FUNC switch and one of the F1 to F5 switches are pressed together, the current settings are saved in the F switch (F1 to F5) concerned.

 Wait appears at the bottom right of the screen while the settings are being saved.

Do not turn off the power during this process. If the power is turned off while the settings are being saved, the initial settings may be saved instead of the settings to be saved.

To load the saved settings, establish the option mode, and press the F switch (F1 to F5) in which the settings were saved.

In the multi mode, all switches except for the INPUT switch, FREEZE switch, FUNC switch and LOCK switch are canceled. Before any further adjustments are to be made, another mode must be established and settings selected.

In the multi mode, all switches except for the INPUT switch, FREEZE switch, FUNC switch and LOCK switch are canceled. Before any further adjustments are to be made, another mode must be established and settings selected.

### 3.4.8.1 Multi mode 1 screen

#### <<Functions>>

On this screen, the input images, waveforms (Y only), vectorscope signals and audio level meter are displayed at the same time.

All the values which were set in the PICTURE1 or PICTURE2 mode are valid.

Note: The H Delay, V Delay and MAG settings established in the PICTURE3 mode are always set to OFF in all modes except the PICTURE3 mode. The settings established in all other modes are as follows.

#### [Items common to both the WAVEFORM and VECTOR modes]

SettingItem	Supported by multi mode 1 screen
Scale color	Setting
Cursor	Not displayed
Line select	Disabled

#### [WAVEFORM mode]

SettingItem	Supported by multi mode 1 screen
Parade display/overlay display	Disabled
Y/G ON/OFF	Always displayed
Pb (Cb)/B ON/OFF	Always not displayed
Pr (Cr)/R ON/OFF	Always not displayed
SWEEP	Fixed at 1H
GAIN	Fixed at initial value
MAG	Fixed at initial value
Vertical (GAIN) scroll	Fixed at initial value
Horizontal scroll	Fixed at initial value
YPbPr/GBR of waveforms	Fixed at YPbPr
ON/OFF for V Anc (Wave)	Setting
ON/OFF for H Blank	Setting
Scale %V	Setting
Filter	Setting
Color, brightness of waveforms	Setting

#### [VECTOR mode]

SettingItem	Supported by multi mode 1 screen
GAIN	Setting
ON/OFF for V Anc (Vect)	Setting
Filter	Setting
Color of vector	Setting

The audio level meter indicates the level as follows in the multi mode.

Audio standards: BTA-S-006B and SMPTE 272M-A

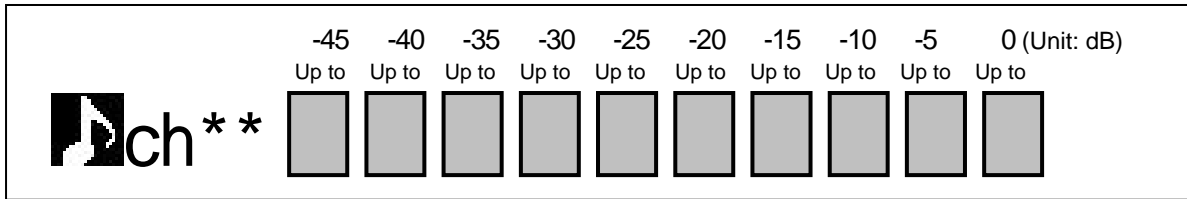

**Caution**

Audio levels below -50 dB are not shown.

The audio level meter appears only when SDI signals are selected.

If the sync signal has been set to an external reference signal, the level meter may malfunction albeit infrequently.

In the following cases, audio data cannot be sampled by this monitor:

When the HD format is used:

When ADF of the audio ancillary data does not come immediately after the CRC data

When the SD format is used:

When ADF of the audio ancillary data does not come immediately after EAV

#### [Description of operations]

Switch	Description of function
FUNC switch	Use this to switch the display to the multi mode 2 screen. (Refer to Section 3.4.8.2.)
F1 switch	(Not used)
F2 switch	(Not used)
F3 switch	(Not used)
F4 switch	(Not used)
F5 switch	(Not used)

### 3.4.8.2 Multi mode 2 screen

#### <<Functions>>

On this screen, the input images and waveforms are displayed at the same time.

All the values which were set in the PICTURE1 or PICTURE2 mode are valid.

Note: The H Delay, V Delay and MAG settings established in the PICTURE3 mode are always set to OFF in all modes except the PICTURE3 mode. The settings established in all other modes are as follows.

SettingItem	Supported by multi mode 1 screen
Scale color	Setting
Cursor	Not displayed
Line select	Disabled

#### [WAVEFORM mode]

SettingItem	Supported by multi mode 1 screen
Parade display/overlay display	Setting
Y/G ON/OFF	Setting
Pb (Cb)/B ON/OFF	Setting
Pr (Cr)/R ON/OFF	Setting
SWEEP	Fixed at 1H
GAIN	Fixed at 50%
MAG	Fixed at initial value
Vertical (GAIN) scroll	Fixed at initial value
Horizontal scroll	Fixed at initial value
YPbPr/GBR of waveforms	Setting
ON/OFF for V Anc (Wave)	Setting
ON/OFF for H Blank	Setting
Scale %V	Setting
Filter	Setting
Color, brightness of waveforms	Setting

#### [Description of operations]

Switch	Description of function
FUNC switch	Use this to switch the display to the multi mode 1 screen. (Refer to Section 3.4.8.1.)
F1 switch	(Not used)
F2 switch	(Not used)
F3 switch	(Not used)
F4 switch	(Not used)
F5 switch	(Not used)

### 3.4.9 Option mode

#### <<Functions>>

Input images can be displayed, and the data stored in the F1 to F5 switches in each mode can be loaded. There are no setting items, and only the INPUT switch, FREEZE switch and LOCK switch function.

#### <<Screen>>

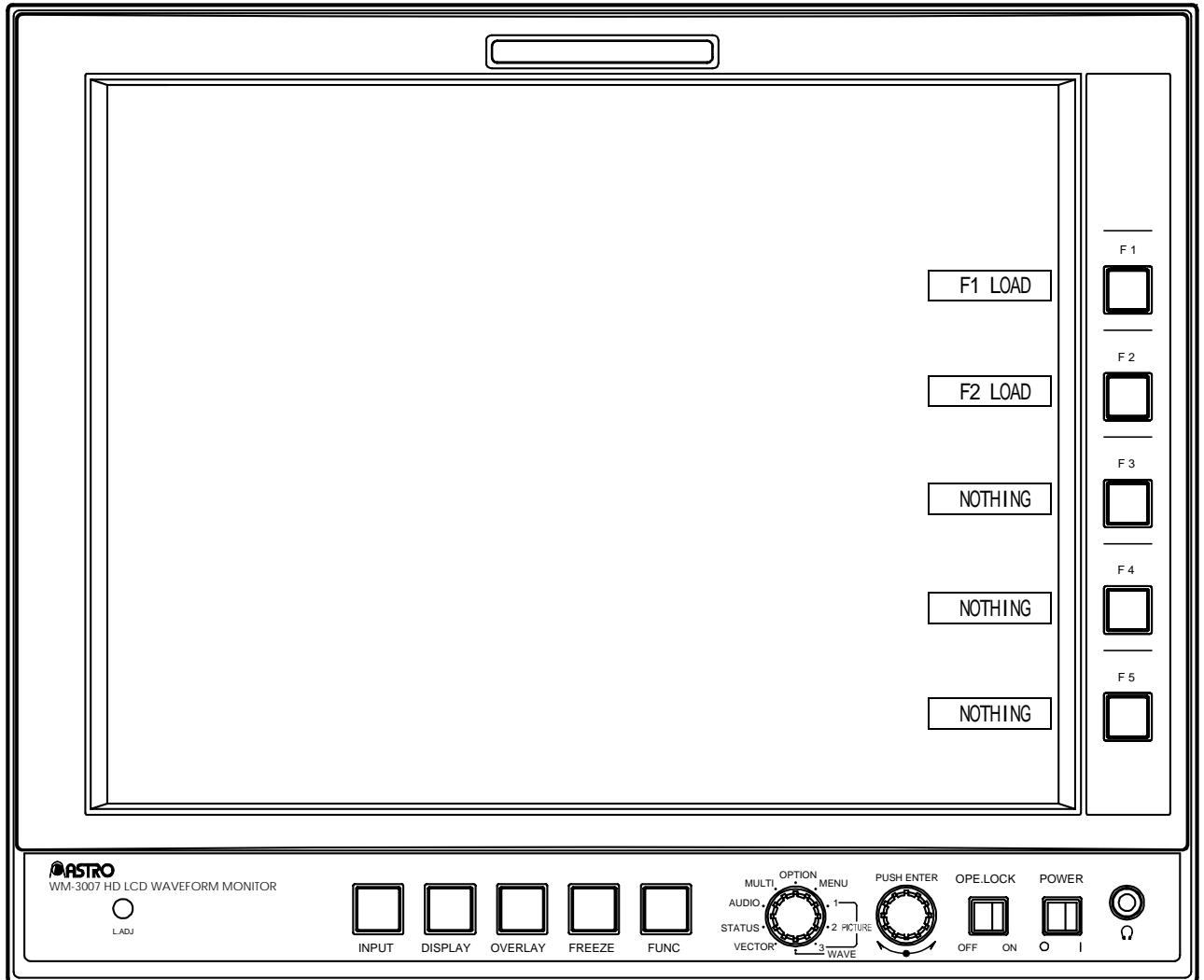

**[Description of operations]**

Switch		Description of function
FUNC switch		Use this to return the display to the regular input image display screen.
F1 switch	F1 LOAD	Use this to load the data stored in the F1 switch.
	NOTHING	Use this to return the display to the regular input image display screen.
F2 switch	F2 LOAD	Use this to load the data stored in the F2 switch.
	NOTHING	Use this to return the display to the regular input image display screen.
F3 switch	F3 LOAD	Use this to load the data stored in the F3 switch.
	NOTHING	Use this to return the display to the regular input image display screen.
F4 switch	F4 LOAD	Use this to load the data stored in the F4 switch.
	NOTHING	Use this to return the display to the regular input image display screen.
F5 switch	F5 LOAD	Use this to load the data stored in the F5 switch.
	NOTHING	Use this to return the display to the regular input image display screen.

**Caution**

When data has been loaded using the F1 to F5 switches, the loaded data will be set as the current user data and remain so unless the FUNC switch or a switch with the **NOTHING** display is pressed.

### 3.4.10 MENU mode

#### 3.4.10.1 Regular screen

##### <<Functions>>

The menu screens can be displayed, and the following settings can be performed.



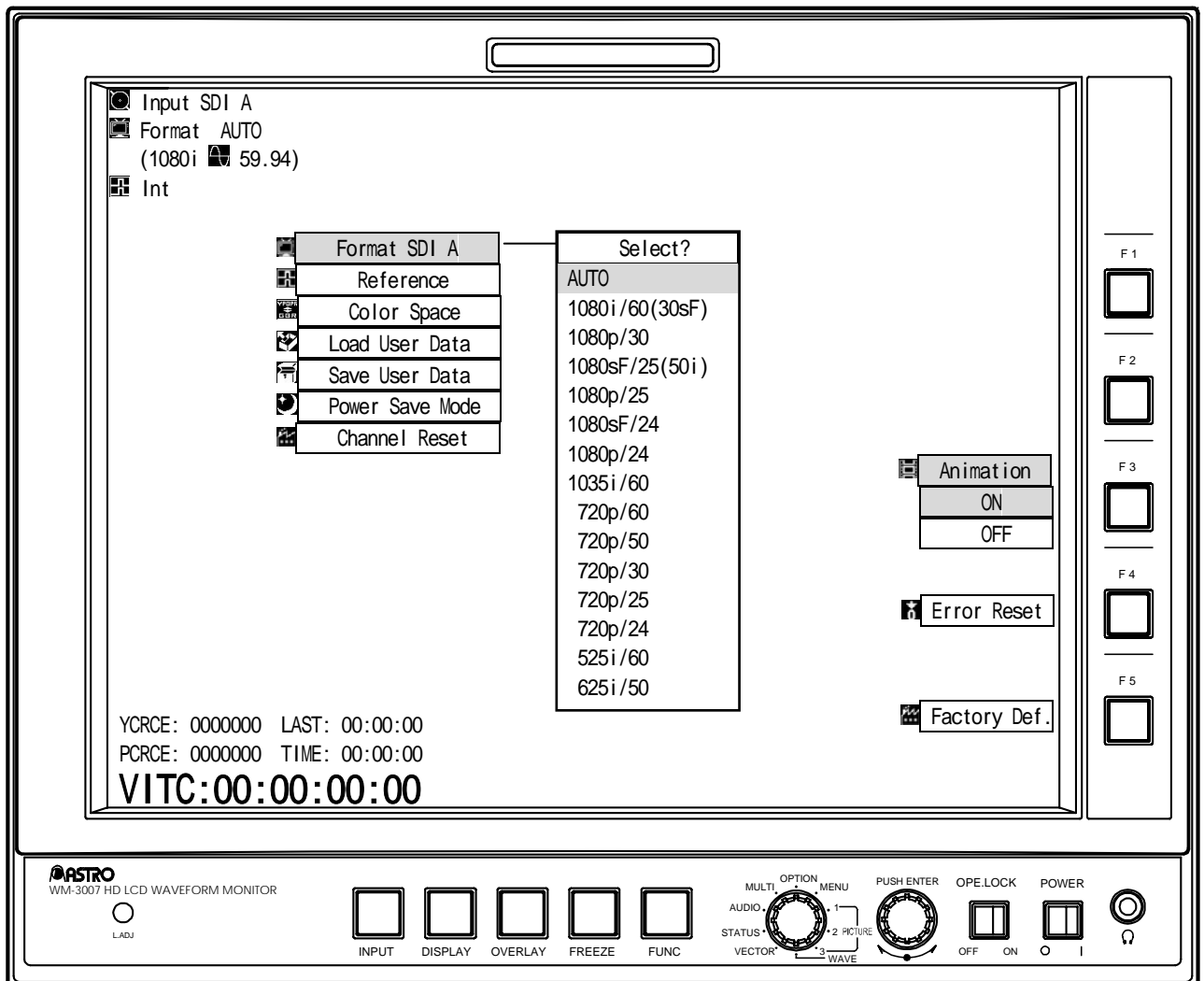

- Format selection
- Reference setting
- Setting of input signal color space
- Loading and saving of user data
- Setting of power-saving mode
- Icon animation setting
- Error count resetting
- Initializing

(\* ) Only when SDI format signals are input can the black burst signal be input as the reference signal. (Analog signals do not support black burst synchronization.)













##### <<Screen>>



**[Description of operations]**

Switch	Description of function
FUNC switch	(Not used)
Turning the adjustment dial	Use the dial to select the items to be set.
Pressing the adjustment dial	Press this to select the format, set the reference or initialize the setting of the currently selected channel (reset to the CRC error count). Refer to section 4.6. If the freeze status is established when the format is selected, it is released.
F1 switch	(Not used)
F2 switch	(Not used)
F3 switch  Animation ON /  Animation OFF	Press this to set the icon animation to ON or OFF.
F4 switch  ErrorCount	Press this to reset the CRC error count and elapsed time.
F5 switch  Factory Def.	When this is held down, the settings of all the channels are initialized, and the CRC error count is reset. Refer to section 4.8.

**[Description of operations]**

Switch	Description of function
 Format *****	The format of the currently selected channel is selected here. When AUTO is selected, the input signals are automatically identified, and their format is followed.
 Reference	The sync signal is selected here. Select  to perform operations with internal synchronization,  to input HD tri-level sync signals,  to input NTSC black burst signals or  to input PAL black burst signals. Bear in mind that black burst synchronization is not supported if the input channel has analog signals.
 Color Space	YPbPr signals or GBR signals are selected here as the input video signals.
 Load User Data	The setting data stored in User1 to User7 is loaded using this menu item.
 Save User Data	The current data is set in User1 to User7 using this menu item.  appears while the settings are being saved. Do not turn off the power during this process. If the power is turned off while the settings are being saved, the initial settings may be saved in User1 to User7 instead of the settings to be saved.
 Power Save Mode	The function for reducing the power consumption to a low level by turning off the LCD backlight can be selected here. When a specific period of time has elapsed without the WM-3007-T having been operated, the LCD backlight is set to OFF, and the lower power consumption mode is established. If any switch is pressed in this mode, the LCD backlight comes back on, and the regular status is restored.
 Channel Reset	The setting items of the currently selected channel are restored to the initial statuses using this menu item. (Refer to Section 4.8.)



Bear in mind that malfunctioning will occur if the reference signal is a signal which is not supported. (Refer to Section 4.7.)  
Even if the reference signal is problem-free, the display screen may shift to the left or right by one pixel before or after.

### 3.4.10.2 Color setting screen

#### <<Functions>>

When the OVERLAY switch is held down in the MENU mode, the following setting can be performed.

- Character color

#### <<Screen>>

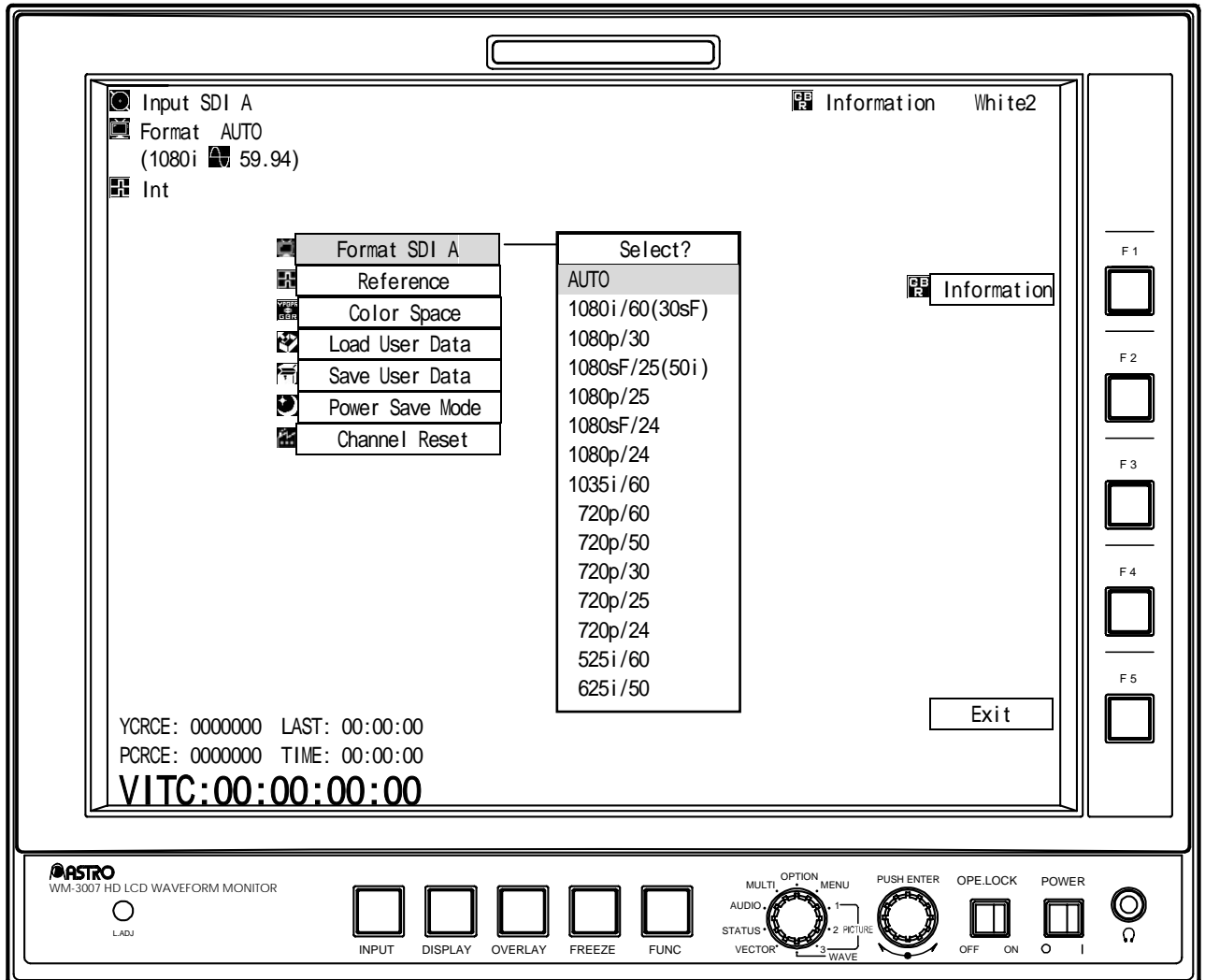

#### [Description of operations]

Switch	Description of function
FUNC switch	Use this to return the display to the regular screen. (Refer to section 3.4.10.1)
F1 switch 	Press this to select the color (any of 63 colors) of the characters using the adjustment dial. When the adjustment dial is pressed, the character color is restored to the initial value.
F2 switch	(Not used)
F3 switch	(Not used)
F4 switch	(Not used)
F5 switch 	Use this to return the display to the regular screen. (Refer to section 3.4.10.1)
OVERLAY switch	When this is held down, the display is returned to the regular screen. (Refer to section 3.4.10.1)

## CHAPTER 4 MAIN SPECIFICATIONS

### 4.1 Input formats

Format		Frame Rate (Hz)	Active Line per Frame	Total Line Per Frame	Line Frequency (kHz)	Samples per Active Line	Samples per Total Line	Scanning *1	*2
1035i/60	1035i/59.94	30/1.001	1035	1125	33.72	1920	2200	i	(1)
	1035i/60	30	1035	1125	33.75	1920	2200	i	
1080i/60	1080i/59.94 1080sF/29.97	30/1.001	1080	1125	33.72	1920	2200	i sF	(1) (2)
	1080i/60 1080sF/30	30	1080	1125	33.75	1920	2200	i sF	(1) (2)
1080p/30	1080p/29.97	30/1.001	1080	1125	33.72	1920	2200	p	(2)
	1080p/30	30	1080	1125	33.75	1920	2200	p	
1080sF/25 (1080i/50)	1080sF/25 1080i/50	25	1080	1125	28.13	1920	2640	sF i	(2)
1080p/25	1080p/25	25	1080	1125	28.13	1920	2640	p	(2)
1080sF/24	1080sF/23.98	24/1.001	1080	1125	26.97	1920	2750	sF	(2)
	1080sF/24	24	1080	1125	27.00	1920	2750	sF	
1080p/24	1080p/23.98	24/1.001	1080	1125	26.97	1920	2750	p	(2)
	1080p/24	24	1080	1125	27.00	1920	2750	p	
720p/60	720p/59.94	60/1.001	720	750	44.96	1280	1650	p	(3)
	720p/60	60	720	750	45.00	1280	1650	p	
720p/50	720p/50	50	720	750	36.00	1280	1980	p	(3)
720p/30	720p/29.97	30/1.001	720	750	22.48	1280	3300	p	(3)
	720p/30	30	720	750	22.50	1280	3300	p	
720p/25	720p/25	25	720	750	18.75	1280	3960	p	(3)
720p/24	720p/23.98	24/1.001	720	750	17.98	1280	4125	p	(3)
	720p/24	24	720	750	18.00	1280	4125	p	
525i/60	525i/59.94	60/1.001	487	525	15.73	720	858	i	(4)
625i/50	625i/50	50	576	625	15.63	720	864	i	(4)

\*1: Scanning abbreviations  
 i = Interlace  
 sF = Segmented Frame  
 p = Progressive

\*2: Standards  
 <1> BTA S-001B, S-002B, S-004B complied with  
 <2> SMPTE 274M complied with  
 <3> SMPTE 296M complied with  
 <4> SMPTE 259M complied with

## 4.2 Input formats

SDI input specification	Specification	
SDI input	HDTV	BTA S-004B and SMPTE 292M standards complied with, NRZI SDI signal
	SDTV	SMPTE 259M standards complied with, NRZI SDI signal
	Field (frame) frequency, 60.00/59.94 [Hz], etc. automatically scanned Automatic scanning of input format enabled	

Analog input specification	Specification
HDTV YPbPr input	BTA S-001B, SMPTE 274M and SMPTE 296M standards complied with
	Field frequency, 60.00/59.94 [Hz], etc. automatically scanned Automatic scanning of input format enabled
	Synchronization: Y (or G) on Sync Video signals: 75-ohm $\pm 5\%$ termination (ON/OFF selectable) Signal accuracy: Less than $\pm 3\%$ Horizontal jitter: Less than 10ns

Reference input specification	Specification
HDTV tri-level sync signals	BTA S-001B, SMPTE 274M and SMPTE 296M standards complied with Field frequency, 60.00/59.94 [Hz], etc. automatically scanned Automatic scanning of input format enabled 75-ohm $\pm 5\%$ termination (ON/OFF selectable)
NTSC/PAL black burst signal	SMPTE 170M standards complied with 75-ohm $\pm 5\%$ termination (ON/OFF selectable)

## 4.3 Display system

Display system	Specification
Liquid crystal	a-Si TFT LCD
Colors displayed	16,777,216 colors
Contrast ratio	400: 1(Typ)
Response time	25ms(Typ)
Angle of view	170 degrees vertically, 170 degrees horizontally
Brightness	350cd/m <sup>2</sup> (max)
Screen size	8.4 inch
Resolution	1024(H) $\times$ 768(V) Pixels
Image area	HDTV: 960(H) $\times$ 540(V) Pixels SDTV (525i/60): 720(H) $\times$ 487(V) Pixels SDTV (625i/50): 720(H) $\times$ 574(V) Pixels
Pixel pitch	0.1665 (W) $\times$ 0.1665(H) mm

## 4.4 Headphones output

Maximum output	10mW $\pm$ 5% (32 $\Omega$ /1kHz)
Frequency response	100Hz to 20kHz (0dB to -3dB) Audio signals are output when 48 kHz embedded sound has been multiplexed in the SDI signals.

## 4.5 Concerning the adjustment values

- **Brightness**      The offset level of the luminance signal can be varied in the range from -50.00 to +50.00%.

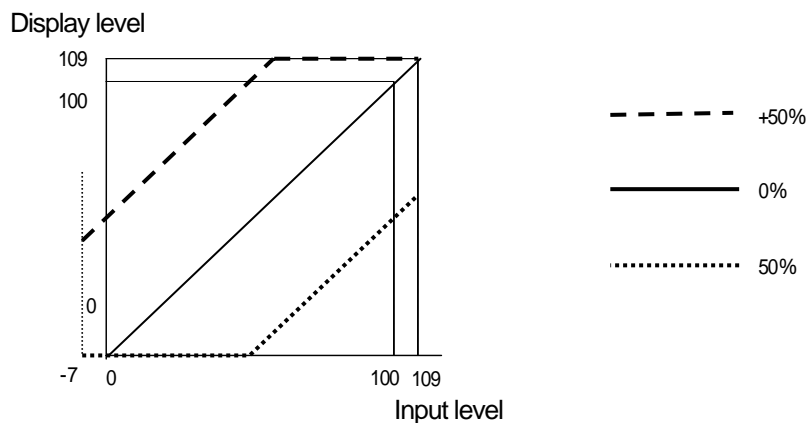

- **Y gamma**      The Y gamma can be corrected in the range from 0.500-2.000; when 2.000 is exceeded, "Effect" results.

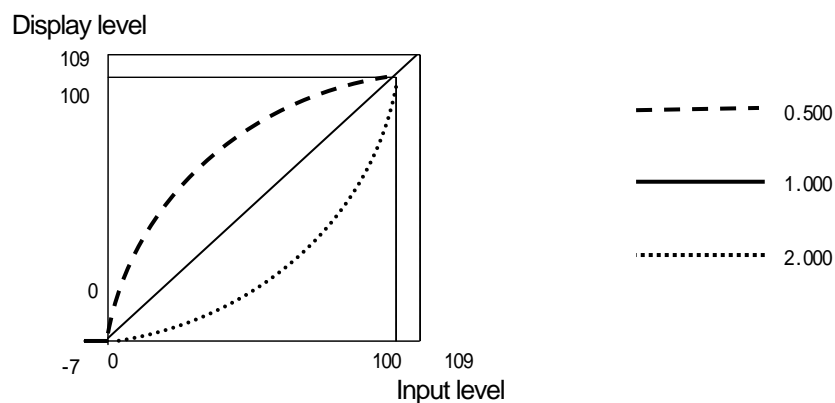

- Contrast The level of the luminance signal can be varied in the range from 0.0-200.0%.

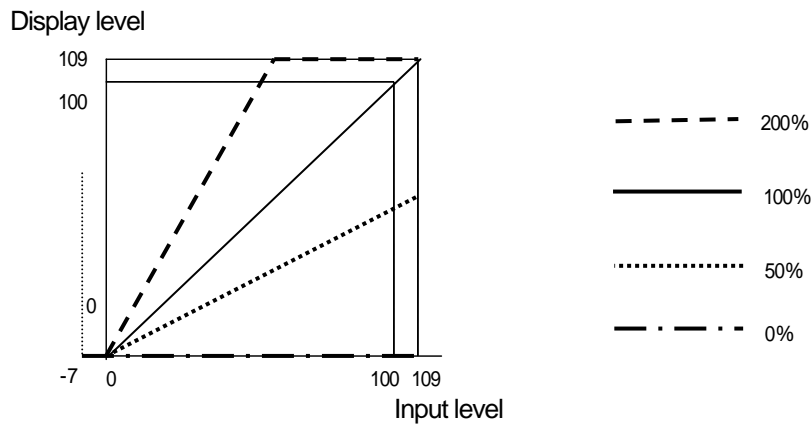

- Chroma, Pb (Cb), Pr (Cr) The level of the chrominance signals can be varied in the range from 0.0-200.0%.

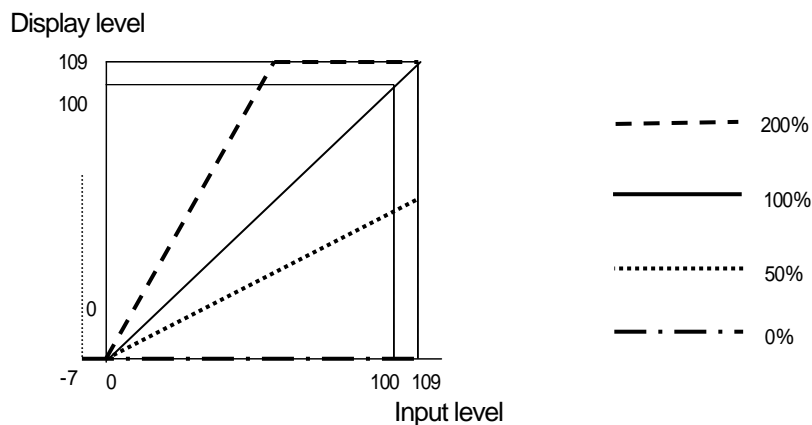

#### Definitions of input levels used in this chapter

Input level		0	100
SDI	Y	Digital value: 64	Digital value: 940
	Pb/Pr	Digital value: 64	Digital value: 960
Analog	Y	0mV	+700mV
	Pb/Pr	-350mV	+350mV

#### Definitions of display levels used in this chapter

Display level	0	100
	Minimum level	Status supporting input level 100 in initial status

## 4.6 Concerning the picture magnification display function

### x2 status

- With a  $1920 \times 1080$  resolution

The  $1024 \times 768$  image near the center is cropped from the image area and displayed. Even at the  $1920 \times 1035$  resolution, the processing is the same as for  $1024 \times 768$  images.

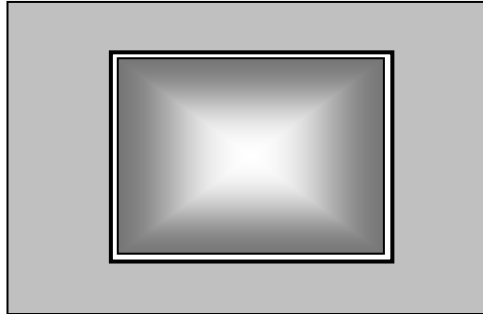

- With a  $1280 \times 720$  resolution

The  $1024 \times 720$  image near the center is cropped from the image area and displayed.

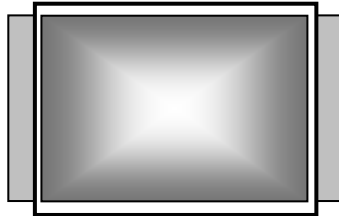

- With a  $720 \times 487$  or  $720 \times 576$  resolution

The  $512 \times 384$  image near the center is cropped from the image area and displayed.

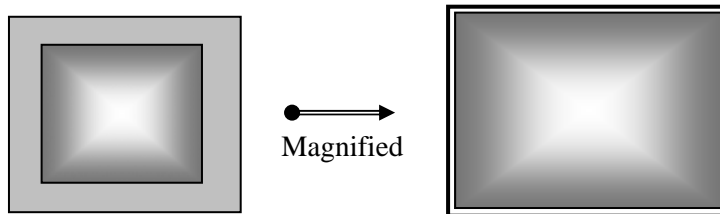

Note: Description of displays



This indicates the image.



This indicates the LCD screen



This indicates the magnified image.

**x4 status**

- With a  $1920 \times 1080$  resolution

The  $512 \times 384$  image near the center is cropped from the image area and displayed. Even at the  $1920 \times 1035$  resolution, the processing is the same as for  $1024 \times 768$  images.

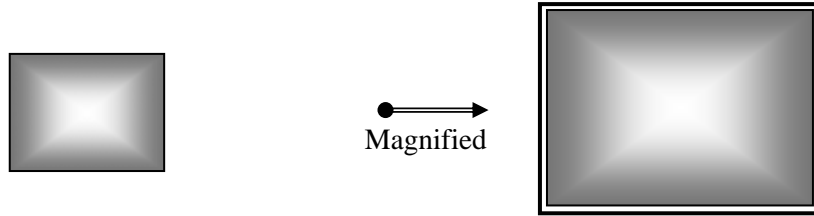

- With a  $1280 \times 720$  resolution

The  $512 \times 384$  image near the center is cropped from the image area and displayed.

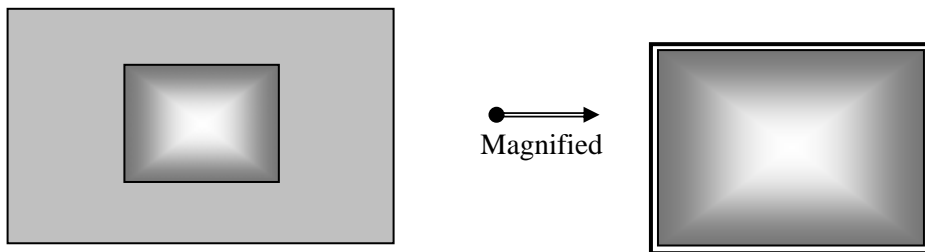

- With a  $720 \times 487$  or  $720 \times 576$  resolution

The  $256 \times 192$  image near the center is cropped from the image area and displayed.

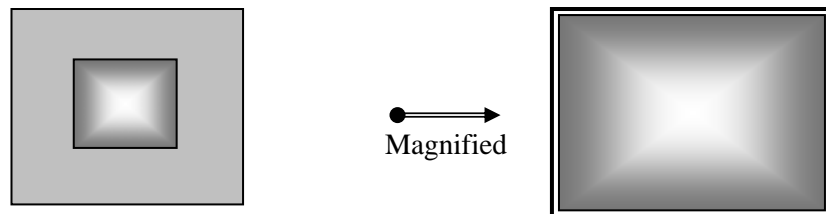

Note: Description of displays



This indicates the image.



This indicates the LCD screen



This indicates the magnified image.



## 4.8 Settings at initialization

The settings established when the WM-3007-T was shipped from the factory or when they have been initialized are listed below.

### Common setting items

The settings for the following items are the same whether for the SDI A, SDI B or analog channels.

These settings are factory default settings, and they are not initialized unless the settings of all the channels are initialized.

SettingItem	Setting/adjustment range	Initial value
Input	SDI A, SDI B, Analog	SDI A
Display	ON, OFF	ON
Overlay	ON, OFF	OFF
Half Turn	ON, OFF	OFF
Freeze (*)	ON, OFF	OFF
G-Bright	-50.0 to +50.0%	0.0%
B-Bright	-50.0 to +50.0%	0.0%
R-Bright	-50.0 to +50.0%	0.0%
G-Contrast	0.0 to 200.0%	100.0%
B-Contrast	0.0 to 200.0%	100.0%
R-Contrast	0.0 to 200.0%	100.0%
G-Gamma	1.100 to 4.400	2.200
B-Gamma	1.100 to 4.400	2.200
R-Gamma	1.100 to 4.400	2.200
Color temperature	D65, D93	D65
Marker	ON/OFF (Types of markers: FRAME, CENTER, USER, 95%, 93%, 88%, 80%, 4:3, 13:9, 14:9, 2.35:1, 1.85:1, 1.66:1)	OFF (Types of markers: FRAME, CENTER)
User Marker H/V	0 to 99%	50%
H Delay( )	ON, OFF	OFF
V Delay (*)	ON, OFF	OFF
MAG	x1, x2, x4	x1
Parade/Overlay	Parade, Overlay	Parade
Y	ON, OFF	ON
Pb(Cb)	ON, OFF	ON
Pr(Cr)	ON, OFF	ON
LineSelect	ON, OFF	OFF
SWEEP	1H, 2H, 1F, 2F	1H
GAIN (WAVEFORM mode)	x0.03 to x7.97	x1
CTR Pos. C	Aligned, Center	Aligned
MAG	x1, x2, x4	x1
H cursor	ON, OFF	OFF
V cursor	ON, OFF	OFF
MOVE	BASE, OFFSET, TRACK	BASE
Waveform	YPbPr, GBR	YPbPr

SettingItem	Setting/adjustment range	Initial value
V Anc (Wave)	ON, OFF	OFF
H Blank	ON, OFF	OFF
Scale (unit)	%, V, Non	%
Filter (Wave)	NON, LPF, Average	LPF
GAIN (VECTOR mode)	x0.03 to x7.97	Fix x1
V Anc (Vect)	ON, OFF	OFF
Scale (Display)	100%, 75%	100%
Filter (Vect)	NON, LPF, Average	LPF
Cardinal numbers	HEX, DEC, OCT, BIN	HEX
GAIN (AUDIO mode)	Fix x1, x2, x4, x8, x16	Fix x1
Animation	ON, OFF	ON
Power Save Mode	1, 5, 10, 15, 30, 60, NON	NON

(\*) These settings are not stored in the memory. They are always OFF when the power is turned on.

## Setting items by channel

The following items are set separately for the SDI A, SDI B and analog channels.

SettingItem	Setting/adjustment range		Initial value
Bright	-50.0 to +50.0%		0.00%
Contrast	0.0 to 200.0%		100.0%
Pb (Cb)	0.0 to 200.0%		100.0%
Pr (Cr)	0.0 to 200.0%		100.0%
Y Gamma	1.100 to 4.400		2.200
Peaking	OFF, 1 to 100		OFF
Filter	ON, OFF		OFF
Mono	ON, OFF		OFF
Green	ON		ON
Blue	ON		ON
Red	ON		ON
Volume	0 to 255		128
Output	1CH to 16CH		L:1CH/R:2CH
Format	SDI	All 15 types	AUTO
	Analog	All 13 types	AUTO
Reference	SDI	Int, Ref HD, Ref BB(525),Ref BB(625)	Int
	Analog	Int, Ref HD	Int
Color Space	YPbPr, GBR		YPbPr
Information Color	G: 0 to 3 B: 0 to 3 R: All 63 colors (black excluded) for 0 to 3		White2 (G: 2, B: 2, R: 2)
Marker Color	G: 0 to 3 B: 0 to 3 R: All 64 colors		White3 (G: 3, B: 3, R: 3)
Scale Color	G: 0 to 3 B: 0 to 3 R: All 63 colors (black excluded) for 0 to 3		White1 (G: 1, B: 1, R: 1)
Waveform Color	Color1 to 31 R: All 62 colors for White 1 to 31		Color15
Cursor Color	G: 0 to 3 B: 0 to 3 R: All 63 colors (black excluded) for 0 to 3		Yellow2 (G: 2, B: 0, R: 2)
Vector Color	Blue: 1 to 32 Red: 1 to 32 Green: 1 to 32 White: 1 to 32 R: All 160 colors		Green16

SettingItem	Setting/adjustment range	Initial value
Status Color	G: 0 to 3 B: 0 to 3 R: All 63 colors (black excluded) for 0 to 3	White2 (G: 2, B: 2, R: 2)
Audio Meter	G: 0 to 3 B: 0 to 3 R: All 63 colors (black excluded) for 0 to 3	White2 (G: 2, B: 2, R: 2)
Audio Vector	Blue: 1 to 32 Red: 1 to 32 Green: 1 to 32 R: All 63 colors (black excluded) for 0 to 3	Green32

## 4.9 General specifications

### WM-3007-T operating environment and ratings

Operating temperature	0 to 40°C
Operating humidity	(no condensation must be allowed to form)
Rated voltage	10-18V DC
Power consumption	25W (when HD-SDI signals are input)
Service life	50,000 hours (LCD backlight)
Dimensions	215(W) × 177(H) × 90 (D) mm (excluding protrusions) 215(W) × 177(H) × 112 (D) mm (including protrusions)
Weight	Approx. 2.0 Kg

### Operating environment and ratings for accessory AC/DC adapter

Rated output voltage	12V ±5%	
Rated output current	5.0A	
Maximum output power	60W	
Input voltage	Rating: 100 to 240V (AC)	
Input frequency	Rating: 50/60 Hz	
Output plug polarities	Pin 1	GND
	Pin 2	NC
	Pin 3	NC
	Pin 4	+12V

### 4.10 Outline drawings

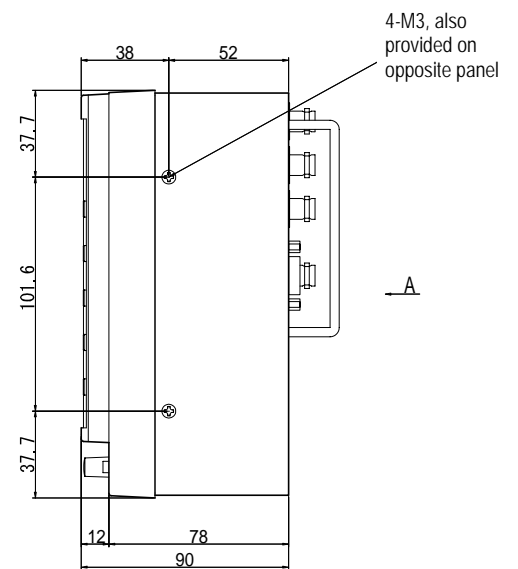
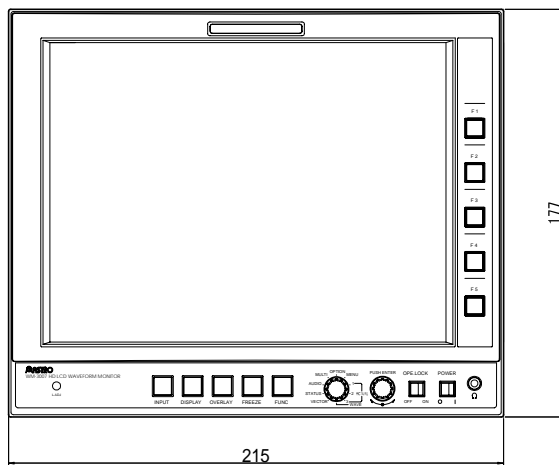
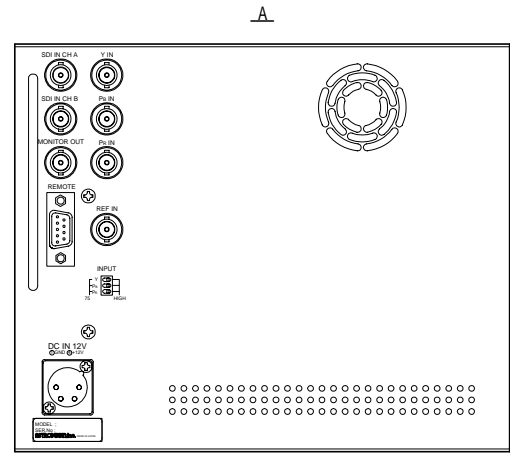
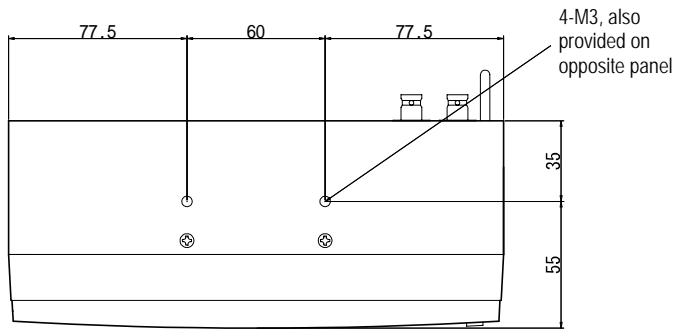

## CHAPTER 5 STANDARD AND OPTIONAL ACCESSORIES

### 5.1 Standard accessories

WM-3007-T instruction manual	1 copy
AC/DC adapter	1 pc (*1)

## CHAPTER 6 MAINTENANCE AND RELATED ASPECTS

### ■ When the monitor does not function properly

Symptom	Checkpoint
The images are not displayed properly.	<ul style="list-style-type: none"> <li>• Are the format settings correct?</li> <li>• Is the  Color Space (YPbPr/GBR) setting correct?</li> <li>• Are the input channel settings correct?</li> <li>• Is the reference signal setting correct?</li> </ul>
The switches on the front panel do not work.	<ul style="list-style-type: none"> <li>• Is the LOCK switch at the ON position?</li> </ul>
The picture quality is poor.	<ul style="list-style-type: none"> <li>• Check the image adjustments in the PICTURE1 mode.</li> </ul>

### ■ The following situations are not indicative of trouble or malfunctioning.

The following conditions or phenomena may arise due to the properties inherent to liquid crystal.

- The response time, brightness and colors of the liquid crystal may vary depending on the ambient temperature.
- Depending on what the liquid crystal panel is displaying, unevenness in the brightness, flicker, vertical stripes or very small spots may be visible.
- The optical characteristics (such as the brightness and display unevenness) of liquid crystal change according to the cumulative operation time. They are particularly prone to change at low temperatures.
- The display colors may vary depending on the view angle.
- Noise may occur on the startup screen.
- Long-term image lag may occur. Avoid displaying the same patterns for prolonged periods of time.

### ■ When trouble or malfunctioning occurs

- In the unlikely event that trouble or malfunctioning should occur, contact your dealer or an Astrodesign sales representative.
- The user will be charged for repairs and parts replacement even within the warranty period if the trouble should occur in the LCD panel.

### ■ Concerning this manual

- This manual may not be copied or transferred in whole or in part without permission.
  - 1) The contents and specifications of this manual are subject to change without notice for the purposes of improving quality.
  - 2) Although this manual has been prepared with painstaking care, the user is asked to contact Astrodesign if any ambiguities, mistakes, omissions or other shortcomings are noticed.
- An incorrectly collated manual or a manual with missing pages will be replaced.
- All copyrights pertaining to this manual are the property of Astrodesign.
- The text of this manual may not be copied or transferred in whole or in part without permission.

### ■ In using the WM-3007-T

- The manufacturer will not be liable for any outcome which results from the operation of the product.
- The products and product names mentioned in this manual are the trademarks and registered trademarks of the companies concerned.
- All inquiries concerning this product should be addressed to your dealer or to the manufacturer at the contact numbers given below.

### **ASTRODESIGN, INC.**

Head Sales Division      2-6-17 Haramachi, Meguro-ku, Tokyo, Japan 152-0011  
Tel: <03> 5720-5300, Fax: <03> 5720-6353

Osaka Sales Office      1-18-27-1010 Higashi-Nakajima, Higashi-Yodogawa-ku, Osaka, Japan  
533-0033  
Tel: <06> 6328-8558, Fax: <06> 6328-5058